

GPS 125 SOUNDER

MARINE
NAVIGATOR



OWNER'S MANUAL
&
REFERENCE

 **GARMIN**®

Software Version 2.0 or above

© 1997 GARMIN Corporation
1200 E. 151st Street, Olathe, KS USA 66062
Tel: 913-397-8200 or 800-800-1020
Fax: 913-397-8282
Web Site Address: www.garmin.com

GARMIN (Europe) Ltd.
Unit 5, The Quadrangle, Abbey Park, Romsey, SO51 9AQ, U.K.
Tel: 011-44-1794-519944
Fax: 011-44-1794-519222

GARMIN (Taiwan) Corp.
4th Fl., No. 1., Lane 45,
Pao-Hsing Road,
Hsin Tien, Taiwan R.O.C.
Phone: 886.02.917.3773
Fax: 886.02.917.1758

All rights reserved. No part of this manual may be reproduced or transmitted in any form or by any means, electronic or manual, including photocopying and recording, for any purpose without the express written permission of GARMIN.

Information in this document is subject to change without notice. GARMIN reserves the right to change or improve its products and to make changes in the content without obligation to notify any person or organization of such changes or improvements.

GARMIN, AutoLocate, and TracBack are all trademarks of GARMIN Corporation and may not be used without the expressed permission of GARMIN.

July 1997 Part #190-00111-00 Rev. B Printed in Taiwan.

GPS 125 SOUNDER OPERATOR'S MANUAL

INTRODUCTION

Overview

Welcome to the easiest-to-use combination GPS/Depth Sounder on the water! The GPS 125 Sounder represents GARMIN's continuing commitment to provide mariners with quality navigation and fishfinding information in a versatile, accurate, and user-friendly design which will be useful for years to come. It is important that you take the time to read through the operator's manual to understand the operating features of the GPS 125 Sounder. The manual is organized into four sections for your convenience:

Introduction gives a quick overview of the manual and contains the table of contents and glossary of navigation terms.

Getting Started takes you through step-by-step instructions to initialize the receiver for first-time use and introduces you to the basic features of the unit with a quick-start orientation to the GPS 125 Sounder. This section has been designed to acquaint you with the unit and provide a basic working knowledge necessary to use the unit in typical conditions.

Reference provides detailed explanations of the advanced features and operations of the GPS 125 Sounder in a topical format. This allows you to concentrate on a specific topic quickly, without reading through entire sections of text that you may not need.

The **Appendix** section contains installation instructions and items with multiple listings, such as: map datums, time offsets, and the index.

See your GARMIN dealer for accessories including our PC kit and standard or temperature reading in-hull and transom-mount transducers.

Thanks for choosing the GARMIN GPS 125 Sounder. We hope it will help you meet all of your navigation and fishfinding needs.



Caution

The GPS system is operated by the government of the United States, which is solely responsible for its accuracy and maintenance. The system is subject to changes which could affect the accuracy and performance of all GPS equipment. Although the GPS 125 Sounder is a precision electronic NAVigation AID (NAVAID), any NAVAID can be misused or misinterpreted and, therefore, become unsafe.

Use the GPS 125 Sounder at your own risk. To reduce the risk of unsafe operation, carefully review and understand all aspects of this Operator's Manual and thoroughly practice operation using the simulator mode prior to actual use. When in actual use, carefully compare indications from the GPS 125 Sounder to all available navigation sources including the information from other NAVAIDs, visual sightings, maps, etc. For safety, always resolve any discrepancies before continuing navigation.

NOTE: This device meets requirements for Part 15 of the FCC limits for Class B digital devices for home or office use. It has been tested for compliance with all necessary FCC standards. This equipment generates, uses, and can radiate radio frequency energy and, if not installed and used in accordance with the instructions, may cause harmful interference to radio communications. However, there is no guarantee that interference will not occur in a particular installation. If this equipment does cause harmful interference to other equipment, which can be determined by turning the equipment off and on, the user is encouraged to try and correct the interference by relocating the equipment or connecting the equipment to a different circuit than the affected equipment. Consult an authorized dealer or other qualified service technician for additional help if these remedies do not correct the problem. Operation is subject to the following conditions: (1) This device cannot cause harmful interference, and (2) this device must accept any interference received, including interference that may cause undesired operation. The GPS 125 Sounder does not contain any user-serviceable parts. Repairs should only be made by an authorized service center. Unauthorized repairs or modifications could void your warranty and your authority to operate this device under Part 15 regulations.

Table of Contents

SECTION ONE Introduction

Glossary/Navigation Basics	2-4
--------------------------------------	-----

SECTION TWO Getting Started

Turning On and Initializing the Receiver	5-7
Primary Page Overview	8-9
Marking a Waypoint	10
Position Page and Map Basics	11-12
Going to A Waypoint	12
Using the Highway Page and Cancelling a GOTO	13-14
Using The Sounder Page	14-17
Clearing a Map and Turning Off	17

SECTION THREE Reference

Satellite Page	17-19
Position Page	20
Marking, Saving, and Using Waypoints	21-28
TracBack Navigation	29-30
Creating and Using Routes	31-36
Sounder Page	37-40
Map Plotting, Zooming, and Cursor Movement	41-43
Using the Compass and Highway Navigation Pages	44-46
Menu Page and Distance/Sun Calculation	47
Track Log Setup	47-48
Interface Setup and DGPS Interface	49-51
System Setup	51-52
Navigation Setup	53-55
Map Page Setup	55-56
Alarms Setup	57
Sounder Setup	58-61
Navigation Simulator	62-63
Appendix A—Installation	64-69
Appendix B—Wiring and Specifications	70-71
Appendix C—Messages and Time Offsets	72-73
Appendix D—Map Datums	74-76
Appendix E—Index	77-78

Glossary

The GPS 125 Sounder is a powerful navigation tool that can guide you anywhere in the world. To better understand its operation and capabilities, it may be helpful to review the basic terms and concepts briefly explained below.

Other navigation and GPS definitions used in the manual are defined in the appropriate reference sections of the manual.

Almanac Data

Satellite constellation information (including location and health of satellites) that is transmitted to your receiver from every GPS satellite. Almanac data must be acquired before GPS navigation can begin.

Bearing (BRG)

The compass direction from your position to a destination.

Course Made Good (CMG)

The bearing from the “active from” position (your starting point) to your present position.

Crosstrack Error (XTE)

The distance you are off a desired course in either direction.

Desired Track (DTK)

The compass course between the “from” and “to” waypoints.

Differential GPS (DGPS)

An extension of the GPS system that uses land-based radio beacons to transmit position corrections to GPS receivers.

Estimated Time of Arrival (ETA)

The time of day of your arrival at a destination.

Estimated Time Enroute (ETE)

The time left to your destination at your present speed.

Ground Speed (SOG)

The velocity you are traveling relative to a ground position.

Latitude

The north/south measurement of position perpendicular to the earth's polar axis.

Longitude

An east/west measurement of position in relation to the Prime Meridian, an imaginary circle that passes through the north and south poles.

Position

An exact, unique location based on a geographic coordinate system.

Sensitivity

A measure of how sensitive the sounder is to sonar echoes.

Speed Over Water (SOW)

The speed you are traveling over the surface of the water.

Thermocline

A layer of water separating warmer water above from cooler water below.

Track (TRK)

The direction of movement relative to a ground position.

Universal Transverse Mercator (UTM)

A grid coordinate system that projects global sections onto a flat surface to measure position in specific zones.

Velocity Made Good (VMG)

The speed you are traveling in the direction of your destination.

Waypoint

A specific location saved in the receiver's memory.

Whiteline

A term applied to the checkered portion of the sonar display which shows the area of strongest sonar return (typically the bottom).

Navigation
Basics

The GPS 125 Sounder provides steering guidance and navigation information using degrees, a measurement measured in a clockwise direction from a north reference. North is described as 000°, east as 090°, south as 180°, and west as 270°. The diagram and compass rose below provide a graphic illustration of the navigation terms used by the GPS 125 Sounder. More information on basic navigation and GPS are available at your local library or bookstore.

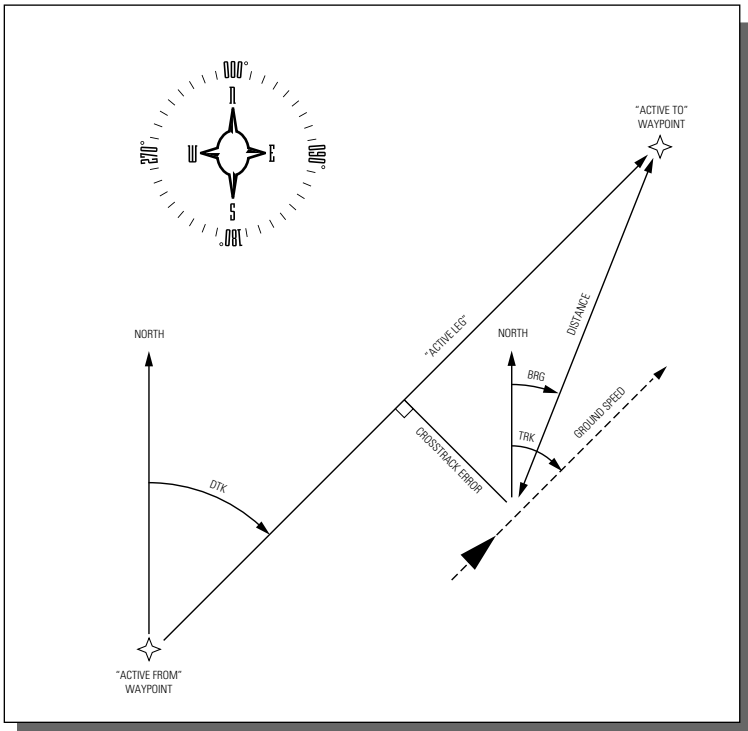

Getting Started with Your GPS

Welcome to the exciting world of GARMIN GPS! The GPS 125 Sounder represents GARMIN's continuing commitment to provide marine users with quality navigation information in a versatile, user-friendly design they will enjoy for years to come. To get the most out of your GPS receiver, be sure to read through the initialization and Getting Started sections of this manual, and refer to the reference section for complete details on the GPS 125 Sounder's advanced features.

Initializing Your GPS for First-Time Use

The first time you power up your new GPS 125 Sounder is an important step in getting the best possible future GPS performance.

Because a GPS receiver can only receive signals from satellites above the horizon, it needs to know what satellites to look for at any given time. By using an almanac (a timetable of satellite numbers and their orbits) stored in the receiver's memory, the GPS 125 Sounder can determine the distance and position of any GPS satellite and then use this information to determine your position.

To obtain this almanac data, your GPS receiver needs to be initialized or given the opportunity to "find itself", the very first time it is turned on. Once you have initialized the unit, the GPS 125 Sounder will compute future fixes more rapidly, usually in a few minutes.

Remember, that initializing the unit is only necessary under the following conditions:

- First-time use from the factory
- If the receiver has been moved over 500 miles from the last calculated position with power off
- If the receiver's memory has been cleared and all stored data has been lost



Welcome Page

The welcome page will appear as soon as the GPS 125 Sounder is turned on and remain on while the unit conducts a brief self-test.

Initialization



The EZinit prompt will automatically appear if the receiver needs to be initialized. The prompt may also appear during normal use if the antenna is shaded.



Use the arrow keypad to highlight the country, region, or state of your present position from the list and press ENTER. If the country is not listed, select the closest country instead.

Initializing the Receiver

The receiver is shipped from the factory in **AutoLocate™** mode, which enables the GPS 125 Sounder to determine its location anywhere in the world. To speed up the initialization process, we recommend using EZinit described below, which will usually provide a fix in a few minutes.

Before you initialize, make sure your GPS 125 Sounder unit, antenna, and transducer have been correctly installed on your boat according to the instructions in Appendix A.

To turn the GPS 125 Sounder on:

1. Press and hold  until the receiver turns on.

The welcome page will be displayed while the unit conducts a self test.

Once testing is complete, the welcome page will be replaced by the status page, with the EZinit prompt ready for you to select one of two initialization methods:

- **Select Country**—allows you to initialize the receiver by selecting your present position from a list of countries in the GPS 125 Sounder's internal database. This usually provides a position fix in a few minutes.
- **AutoLocate™**—allows the GPS 125 Sounder to initialize itself and calculate a position fix without knowing your present position. This usually provides a position fix in 7.5-15 minutes.

If the EZinit prompt has not automatically appeared on the Satellite Page:

1. Press the  key.

Note: If the EZinit prompt appears at any time after you have initialized the receiver (because satellite signals are being obstructed by trees, etc.), highlight 'No Re-Init' with the arrow keypad and press ENTER.

To initialize the receiver:

1. If the 'country' option is not highlighted, press the  key repeatedly to move the field highlight to the 'country' option and press the  key.

Initialization

- Use the ▼ key to scroll through the list options until the country of your present position appears.
- Use ▲ to highlight the country/state/region you're in. If the country you're in is not listed, select another country within 500 miles of your present position.
- Press **ENTER** to finish.

The GPS 125 Sounder will now begin searching for the appropriate satellites for your location and should acquire a position within a few minutes. You can verify that you have acquired a position by watching the Satellite Page transition to the Position Page (provided you haven't pressed any other buttons) or by looking for a '2D NAV' or '3D NAV' status at the top left corner of the Satellite Page.

Initialization Troubleshooting

If you have trouble initializing the receiver or acquiring a position, check the following:

- **Does the antenna have a clear view of the sky?**

If there are nearby buildings, heavy tree cover, a covered boat slip, etc., the unit may not be receiving enough satellite signals to calculate a position.

- **Have you selected the right country/state/region from the EZinit list?**

Check for the correct approximate lat/long on the Position Page or reselect the appropriate country from the list to restart the initialization.

- **Have you moved more than 500 miles from the last calculated position with the receiver off?**

Reinitialize the receiver, selecting the country/state/region of your new location from the EZinit list.

Your unit should now be initialized. If you want to complete the Getting Started Tour at another time, you may now turn the GPS 125 Sounder off (see below) or you may continue.

To turn the GPS 125 Sounder off:

- Press and hold **OFF** for approximately three seconds until the receiver turns off.

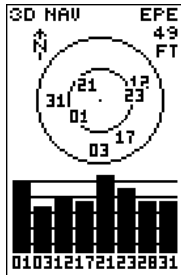

The GPS 125 Sounder's Satellite Page will help you determine which satellites are in view and whether or not any satellites are being "shaded" or blocked from the receiver's antenna.

By monitoring the signal strength bars at the bottom of the page and the sky view, you'll be able to see how moving to another area with a clearer view of the sky will improve satellite reception and speed up signal acquisition.

GETTING STARTED

Primary Pages

Primary Pages

The GPS 125 Sounder uses six primary “pages” to give you information. The pages are arranged in a continual loop and can be easily viewed in forward or reverse order by pressing either the **PAGE** or **QUIT** key. Before we start the tour, let’s briefly look at these pages.

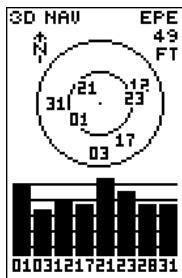
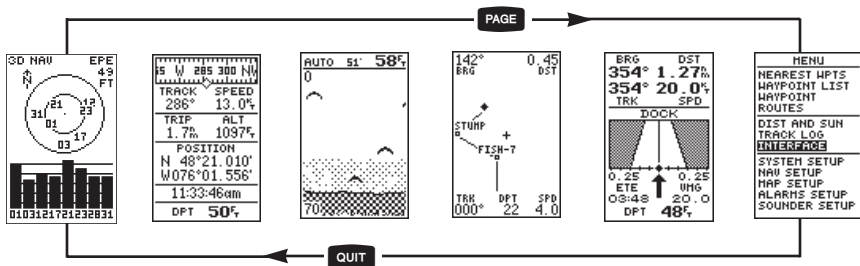

Satellite Page

The Satellite Page will allow you to monitor satellite signal reception and strength.

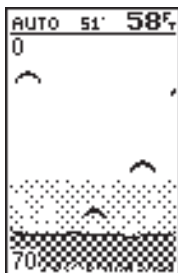

Sounder Page

Satellite Page

The **Satellite Page** shows satellite positions and signal strength. Satellite positions are shown using a “birds-eye-view” display. Signal strength bars are shown for each satellite in use. Satellite status and estimated position error (EPE) are shown in the upper corners.

Position Page

The **Position Page** shows you where you are, what direction you’re heading and how fast you’re going. The top of the page contains a compass tape which is a graphic representation of your heading. Your track and speed are indicated immediately below, with the digital depth displayed at the bottom of the page.



The graphic compass tape reflects your heading only while you are moving.

The rest of the page shows your current position in three dimensions: latitude, longitude and altitude. A trip odometer and 12/24-hour clock are also provided.

Sounder Page

The **Sounder Page** gives a view of the water beneath your boat while displaying sonar contacts and bottom contour.

Primary Pages
& Backlighting**Map Page**

The **Map Page** acts as a window that allows you to view your position, the “path” you have traveled over, and nearby waypoints. A diamond icon in the center of the screen represents your present position. As you move, you will see a thin line, called a track log, appear along the path you have just covered. Names of stored waypoints can also be shown on the map.

The bottom corners of the page will always display your current track and speed, with the digital depth shown in the center. If you are navigating to a waypoint, highlighting an on-screen waypoint, or panning the cursor, the corresponding distance and bearing will be shown at the top corners.

Navigation Page

A navigation page gives you directional guidance when going to a waypoint. The GPS 125 Sounder has two navigation page choices: the Highway Page or the Compass Page. The Highway Page is the default and will be briefly explained here. The Compass Page is covered on pg. 46.

The **Highway Page** uses a graphic highway to show your movement in relation to your desired course. The upper section shows bearing and distance to the waypoint and your current track and speed. The middle portion contains the actual highway. The bottom of the page contains the estimated time enroute (ETE) and your velocity made good (VMG).

Menu Page

The last primary page is the **Menu Page**. The Menu Page gives you access to the GPS 125 Sounder’s waypoint management, route, track log, and setup features through a list of submenus.

Screen Backlighting

The GPS 125 Sounder features three levels of backlighting. Activate the backlight by pressing the POWER key briefly. Each press of the button advances the backlighting to the next level and then turns it off. Backlighting will remain on until turned off.

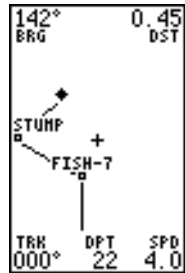
**Map Page**

The Map Page shows your progress on a moving map plotter and gives a bird's-eye-view of surrounding waypoints.

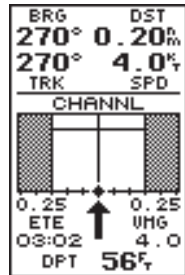
**Highway Page**

With the Highway Page, you will get graphic steering guidance in navigating a route or to a single waypoint.

Marking A
Waypoint

GPS POSITION
Waypoint: 001
N 48°21.010' W075°59.660'
DEPTH - 59 FT
Add to route number: --
SAVE?

To save a waypoint with the default three-digit name, simply press the MARK key followed by the ENTER key. The GPS 125 Sounder will then return to the page previously displayed.

GPS POSITION
Waypoint: D -----
N 48°30.210' W055°10.070'
DEPTH - 71 FT
Add to route number: --
SAVE?

Press the UP arrow to move forward through the alphabet or numbers and DOWN to move backward.

Getting Started Tour

Now that your GPS receiver has been initialized and you are familiar with the primary pages, it's time to take a tour. This is a live tour and is to be conducted with your unit installed and with the boat in the water. The tour will take you through the receiver's basic features and functions as you move about on the water and assumes that the GPS 125 Sounder is turned on, initialized, and that you have not changed any of the factory settings (units of measure, selectable fields, etc.). If these settings have been changed, the pictures and descriptions in this manual may not match what you see on your screen.

Navigation Simulator

If you are not able to take the Getting Started tour with your boat in the water, you may use the built-in navigation simulator to practice using the GPS 125 Sounder. To use the simulator, see pg. 60.

Marking a Waypoint

To begin the live tour, let's take the position you have acquired (either by just initializing the unit or by having turning the unit on) and mark it as a waypoint.

1. Press the **MARK** key to capture and hold your position.



To mark a position, you must have a 2D or 3D fix, or have the receiver in simulator mode. If you try to mark a position without a position fix, a 'No GPS Position' message will be displayed.

The mark position page will appear, showing the captured position and a default 3-digit waypoint name. Let's change the name something more meaningful, like 'DOCK'.

1. Press the **▼** key once to move the field highlight from the 'SAVE?' field to the name field.
2. Press **ENTER** to clear the default name.
3. Press and hold the **▲** key to scroll through the alphabet until the letter 'D' appears.

Marking Waypoint & Map Page

4. Press the **▶** key once to move the character highlight to the next character space.
5. Repeat steps 3 and 4 until the word 'DOCK' is shown.
6. Press **ENTER** to complete entry of the name.
7. Press the **▼** key twice to return the field highlight to the 'SAVE?' field.
8. Press the **ENTER** key to confirm that you want to save the position as a waypoint named 'DOCK'.

The mark position page will now be replaced by the Position Page (or whatever page was displayed prior to pressing the **MARK** key). The 'DOCK' waypoint is now stored in the GPS 125 Sounder's memory, and will remain there until you manually remove it or clear the receiver's memory. For more on waypoint management, see pg. 21-28.

Using the Position and Map Pages

Now that you've marked a position, let's see how the Position and Map Pages can be used to monitor your progress as we head out into the open water.



As always, ensure your primary focus is on boating traffic and monitor the GPS 125 Sounder briefly when operating your boat.

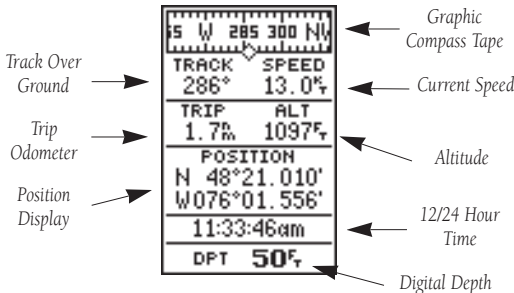

The direction you are moving (track) and your speed are shown on the top of the Position Page, below the graphic compass tape. The latitude, longitude, and approximate altitude of your position--with a resettable trip odometer--are displayed in the middle of the page, with the time of day and digital depth shown below.



The arrow keypad is used for all data entry. Use the UP and DOWN keys to select letters, numbers, or menu options, and use the LEFT and RIGHT keys to move the cursor forward or backward along the line.

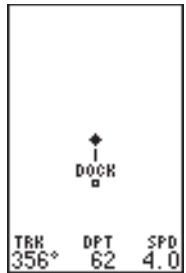

The Map Page displays your present position as a diamond icon and provides a real-time graphic "breadcrumb" display of your track right on the screen.

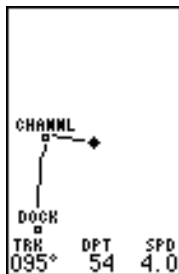
Position/Map
Pages and
GOTO

The moving map's default screen orientation is track up orientation. "Track up" means that your current direction of travel is always up (or towards the top of) the screen. It can also be set for north up, or desired track orientation through the map setup page.



The GOTO waypoint page allows you to select a destination from a list of all available waypoints in the GPS 125 Sounder's memory.

Using the Position and Map Pages (continued)

Now let's change the display to the Map Page and watch the track log of our tour:

1. Press **PAGE** to change from the Position Page to the Map Page.

Your current position is shown as the diamond in the middle of the screen. The dark circle below the diamond represents the position you created, with the line between the two showing your track.

1. Once you have reached an area that allows for general changes in direction without interfering in the passage of other boats, mark your current position again and name this waypoint "CHANNL". (See 'Marking a Waypoint' on pg. 10-11).
2. Next, make a moderate turn in any direction safe for navigation and proceed for another 3 minutes.

Going To a Waypoint

Once you've stored the 'CHANNL' waypoint in memory, you can use the GPS 125 Sounder to guide you to it by performing a simple GOTO. A GOTO is simply the receiver drawing a straight-line course from your present position to the destination you've selected.



Use caution when navigating. A "straight-line" course reflects the shortest distance to a waypoint, and does not navigate around obstructions, such as land or buoys, etc.

Now that you have moved away from 'CHANNL' for three minutes, let's try navigating back to it.

To select a GOTO destination:

1. Press the **GOTO** key. The GOTO waypoint page will appear, displaying all the waypoints in memory in alphabetical order.
2. Use **▲** or **▼** to highlight the 'CHANNL' waypoint.
3. Press the **ENTER** key to confirm that you want to navigate to the displayed waypoint. The Highway Page (default) will appear.

Using the Highway Page

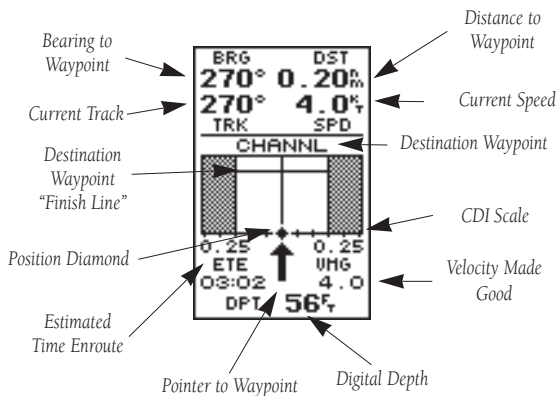

The GPS 125 Sounder's Highway Page provides graphic steering guidance to a destination, with an emphasis on a straight-line course to the desired waypoint and the distance and direction you are off course. The bearing and distance to a waypoint, along with your current track and speed are displayed at the top of the screen, with your estimated time enroute (ETE) and velocity made good (VMG), or the speed you are approaching your destination, shown at the bottom.

As you head toward your destination, the middle section of the screen provides visual guidance to your waypoint on a moving graphic "highway".

Your present position is represented by the diamond in the center of the course deviation scale. The line down the middle of the highway represents your desired track.

As you navigate toward a waypoint, the highway will actually move, indicating the direction you're off course, relative to the position diamond on the CDI scale. When the highway is pointing straight up the screen, the waypoint is directly ahead. If the destination waypoint is to the left, the top of the highway will lead toward the left, and vice versa. To stay on course simply steer in the direction the highway leads (left or right) until the highway leads straight up the page.

GETTING STARTED

Using the Highway Page

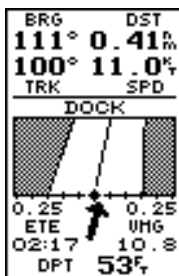

A waypoint is directly ahead when the highway is pointing straight up. In the above example, the waypoint is to the right (111°) of our present course (100°). Turn right until the highway points straight up the screen.



Once you are one minute from the destination (based on your present speed and course), an arrival message will appear on the message page.

*Highway/
Sounder Page &
Cancelling GOTO*

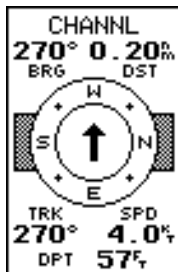

The 125 Sounder will also provide steering guidance with a graphic Compass Page.

To change the display from the Highway Page, press ENTER twice.



Once a GOTO is activated, the GPS 125 Sounder provides steering guidance until the GOTO is canceled. To cancel a GOTO, highlight the cancel prompt at the bottom of the page and press ENTER.

Using the Highway Page (continued)

While navigating, you may use the Compass Page (see picture below left) instead of the Highway Page.

To select the Compass Page:

1. While viewing the Highway Page press **ENTER** twice.

The Compass Page will now become the displayed navigation page. This page provides a directional pointer to your destination by using a compass display to show direction of travel. This provides better steering guidance at slower speeds for travel with many directional changes.

To return to the Highway Page, press ENTER twice.

Cancelling a GOTO

If you decide to stop navigating to the active waypoint, all you have to do is cancel the GOTO.

To cancel an active GOTO:

1. Press the **GOTO** key.
2. Use the arrow keypad to move the field highlight to the 'CANCEL GOTO?' prompt at the bottom of the page and press **ENTER**.

Using the Sounder Page

Now that you have learned the basics of GPS Navigation, let's briefly look at how the GPS 125 Sounder works for you as a fishfinder. The fishfinding features are covered in detail on pg. 37-40.

The top of the Sounder Page shows the range mode being used, the water temperature (if using a temperature-sensitive transducer), and the digital depth, while the middle of the page contains a right-to-left moving sonar image of the water beneath your boat. (Note: items appear as they pass under your transducer. Those objects appearing on the right side of the screen are closer to you than those objects on the left.) **Fish** are displayed as a darkened arch or a fish icon in three different sizes. **Thermoclines** (layers of water separating warmer water above and cooler water below) appear as dotted patterns just above the bottom.

**Sounder Page,
Range Modes, &
Sounder Zoom****Using the Sounder Page (continued)**

The area of strongest sonar return (**whiteline**) is displayed as light and dark checkering. Typically, the bottom will be the primary source of the whiteline. A thin whiteline indicates a softer bottom while a thicker whiteline shows a harder bottom. A **black line** is used to show the point where water meets the whiteline. This black line will follow the bottom contour, along with any significant objects lying on the bottom. Along the left side of the screen (typically) is an **adjustable scale** which shows the current display's range of depth.

Range Modes

The GPS 125 Sounder uses two range modes: auto and manual. 'Auto' displays the most information possible while continuously displaying the bottom. 'Manual' lets you select the displayed range. You may switch between auto and manual modes by using the arrow keypad or by using the sounder setup menu.

To switch from auto to manual mode:

1. Press the ▲ or ▼ keys until the desired depth range is displayed on the depth scale at the left side of the page.
2. Press **ENTER** to confirm the selected range.

To switch from manual to auto mode:

1. Press the arrow keypad up or down until a repeated beep sounds. 'Auto' will be shown in the range field at the top left corner of the screen, and press **ENTER**.

Underwater waypoints

The underwater waypoint feature marks a waypoint's position and its depth. This makes it easier to find and use an object such as a stump for a future fishing location. For instructions on marking an underwater waypoint, see pg. 38.

Sounder Zoom

The sounder zoom function allows you to see the current display picture at 2 times (2X) or 4 times (4X) magnification. 2X means that the screen displayed will now cover 1/2 the range you were originally viewing in twice the detail, and 4X shows 1/4 the original range at four times the detail. Because less area is being shown (in a zoom screen) objects can be seen in greater detail.



GARMIN's exclusive See-Thru technology will allow you to distinguish sonar targets from bottom clutter and thermoclines.

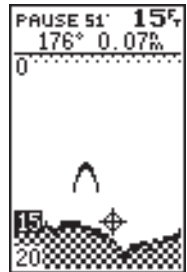

Use the target cursor to mark the desired underwater location.

Note: The bearing and range shown are to the cursor's location from your present position.

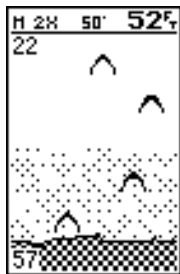
**Sounder Zoom
& Zoom
Window**

Pressing the IN key once while on the Sounder Page activates the 2X Zoom.

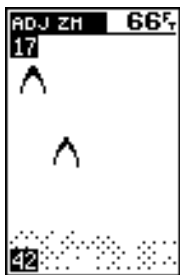

The zoom window may be moved at any time by using the arrow keypad.

The zoom function is accessed by using the IN and OUT key when viewing the Sounder Page.

Once activated, the zoomed picture becomes the Sounder Page display. Note: The zoom function can only be deactivated by pressing the OUT key until the original zoom scale appears.

The zoom function operates in either Auto range or Manual range. Zooming while in Auto will continue to follow the bottom contour, while zooming in Manual will show the selected depth.

To access the sounder zoom function:

1. While viewing the Sounder Page, press **IN** once. The 2X screen will appear. Note: the current zoom scale will be displayed in the upper left corner of the screen.
2. Press **IN** once more to advance to the 4X screen.
3. To deactivate the sounder zoom function, press **IN** once. You may also press and hold **OUT** until the original scale picture appears and a triple beep sounds.

Moving the Zoom Window

You may move the displayed range on a zoomed screen at any time, just as you would a non-zoom screen, by pressing the arrow keypad up or down. This will move the zoom “window”.



If you prefer to keep the window in its new position, you will need to save the change. Note: Saving the new window position requires different steps if you are in Auto range when you move the window versus being in Manual when the window is moved.

To save a zoom window range in Auto:

1. Press the **▲** keypad up to view a shallower range or down to view a deeper range. The range scale on the left side of the zoomed picture will be highlighted.
2. When the window reaches the desired range, press **ENTER** to accept. A ‘Change To Manual Range?’ window will appear. Highlight ‘Yes’ and press **ENTER**.
3. If you do not want to save the range, highlight ‘No’ and press **ENTER**. You may then resume manually moving the zoom window.
4. Press **QUIT** at any time to return to an auto range mode display.







**Clearing the
Map Page &
Power OFF****Moving the Zoom Window (continued)**

To save a zoom window range in Manual:

1. Press the  keypad up to view a shallower range or down to view a deeper range. The range scale on the left side of the zoomed picture will be highlighted.
2. When the window reaches the desired range, press  to accept.
3. If you do not want to save the range, press  to return to the previous window range.

Clearing a Cluttered Map Page Display

After you've used the GPS 125 Sounder for a few trips, you may find that your map display has become a bit messy from keeping track of your every move. For practice, let's clean up the screen by clearing the track log (the plot points left on the Map Page) we've just created during the Getting Started Tour.

1. Press  or  until the Menu Page appears.
2. Use the  key to move the field highlight to the 'TRACK LOG' option.
3. Press  to access the track log page.
4. Press the  key twice to highlight the 'CLEAR LOG?' option. The clear log confirmation page will appear.
5. Use the  key to highlight the 'Yes?' prompt.
6. Press  to finish.

Turning the Receiver Off

You've now gone through the basic operation of your new GPS receiver and probably know a little more than you think about how it works. We encourage you to experiment with the GPS 125 Sounder until it becomes an extension of your own navigation skills. If you encounter any problems using the unit or want to take advantage of the GPS 125 Sounder's more advanced features, refer to the reference section.

To turn the GPS 125 Sounder off:

1. Press and hold the  key for 3 seconds.

TRACK LOG	
RECORD:	Yes
CRITERIA:	
Automatic	
MEMORY USED	
1 of 762	
points (0%)	
CLEAR LOG?	
TRACKBACK?	

Highlight the 'CLEAR LOG?' prompt and press ENTER to clear the track log.

Note: Once all 768 points are used during normal operation, the oldest point will be continuously deleted to make room for the latest track log point to be stored.



Holding the POWER key for three seconds ensures against unwanted shut-off by accidentally pressing the key.

Satellite Page
Overview

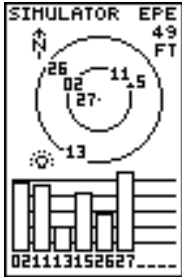

When backlighting is on, a bulb icon will appear on the Satellite Page.

Use the icon to determine if backlighting is turned on during daylight hours.

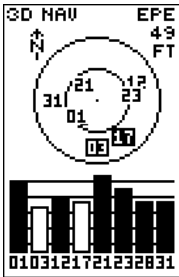

Satellites being tracked but blocked from use (03,17) will be displayed in reverse video, with the corresponding signal strength bar hollow.

Satellite Page

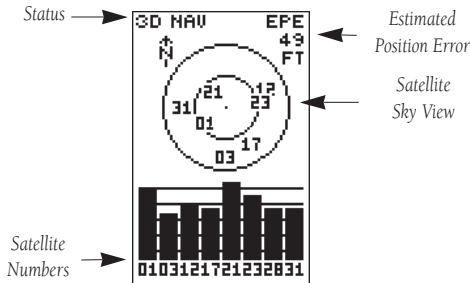

The Satellite Page displays the status of various receiver functions. The status information will help you understand what the GPS 125 Sounder is doing at any given time, and tell you whether or not the receiver has calculated a position fix.

Sky View and Signal Strength Bars

The sky view and signal strength bars give you an indication of what satellites are visible to the receiver, whether or not they are being used to calculate a position fix, and the signal quality. The sky view in the center of the page shows a bird's-eye view of the position of each satellite relative to the receiver's last known position. The outer circle represents the horizon (north up); the inner circle is 45° above the horizon; and the center point is a position directly overhead.

When the receiver is looking for a particular satellite, the corresponding signal strength bar will be blank and the sky view indicator will remain highlighted in reverse video. Once the receiver has found the satellite, a hollow signal strength bar will appear, indicating that the satellite has been found and the receiver is collecting data from it. The satellite number in the sky view will also change from reverse video to normal presentation. As soon as the GPS 125 Sounder has collected the necessary data to use the satellite for positioning, the hollow bar will become solid.

Receiver Status and EPE

Receiver status is indicated at the top left of the screen, with the current horizontal accuracy (estimated position error, in feet or meters) at the top right. The status will show one of the following conditions:

Searching— the GPS 125 Sounder is looking for any available satellites in view.

AutoLocate™— the GPS 125 Sounder is initializing and collecting new almanac data. This process can take 7.5 to 15 minutes.

Acquiring— the receiver is collecting data from available satellites, but has not collected enough data to calculate a 2D fix.

2D Nav (2D Navigation)— at least three satellites with good geometry have been locked onto and a 2-dimensional position fix (latitude and longitude) is being calculated. '2D Diff' will appear when you are receiving DGPS corrections in 2D mode.

3D Nav (3D Navigation)— at least four satellites with good geometry have been locked onto, and your position is now being calculated in latitude, longitude and altitude. '3D Diff' will appear when you are receiving DGPS corrections in 3D mode.

Poor Cvrq (Poor GPS Coverage)— the receiver is no longer tracking enough satellites for a 2D or 3D fix.

Not Usable— the receiver is unusable, possibly due to incorrect initialization or abnormal satellite conditions. Turn the unit off and back on to reset.

SIM (Simulating Navigation)— the receiver is in simulator mode.

EZinit Option Prompt

The Satellite Page also provides access to the EZinit prompt whenever a position fix has not been calculated (the unit must be in searching, AutoLocate, acquiring, simulator or poor coverage status). This allows you to manually reinitialize the unit (see pg. 6-7 for instructions), and is useful if you have traveled over 500 miles with the receiver off and you know it must be initialized to your new position (the GPS 125 Sounder will automatically offer the EZinit prompt after 10 minutes of unsuccessful satellite acquisition).

Receiver Status & EZinit

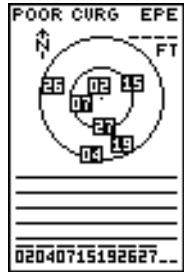

A 'POOR CVRG' status will appear on the Satellite Page if the receiver has lost the satellites required to compute a fix. Make sure the external antenna is not covered and is connected to the GPS 125 Sounder.

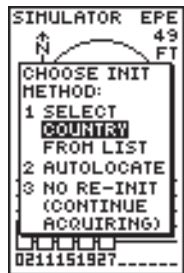

If you travel more than 500 miles with the receiver off, reinitialize the unit to your new position by using the EZinit feature. To access EZinit, press ENTER from the Satellite Page before any satellites are acquired.

Backlighting & Position Page

345 N 015 030 N	
TRACK	SPEED
011°	16.0%
TRIP	ALT
6.5%	1081ft
POSITION	
N 36°42.073'	
W074°29.032'	
12:12:59pm	
DPT 45%	

The speed and track displayed on the Position Page may fluctuate at slow speeds (or when you're standing still) because of position errors caused by Selective Availability.

330 345 N 015 0	
TRACK	SPEED
356°	0.0%
TRIP	ALT
00.0%	1081ft
POSITION	
N 39°00.000'	
W095°00.000'	
22:10:41	
DPT 59%	

To reset the trip odometer, highlight the trip field and press ENTER. Use the LEFT arrow key to clear the distance field, and press ENTER to confirm.

Screen Backlighting

The GPS 125 Sounder features three levels of backlighting. Activate the backlight by pressing the POWER key briefly. Each press of the button advances the backlighting to the next level and then turns it off. Backlighting will remain on until turned off.

Position Page

The GPS 125 Sounder's Position Page shows you where you are, the direction you are heading, and your speed (up to 99.9 mph), and is most useful when you are traveling without an active destination waypoint. A compass tape at the top of the page displays your cardinal heading (while moving), with current track and speed over the ground indicated below. The rest of the page shows your present position in three dimensions (latitude, longitude and altitude). The units of measure for speed, distance, position and altitude are user-selectable through the navigation setup menu (see pg. 53). The 12/24-hour clock and time offset options are available from the system setup menu (see pg. 52).

Trip Odometer

The Position Page also features a resettable trip odometer to measure your total distance traveled.

To reset the trip odometer:

1. Press the ▼ key until the trip field is highlighted.
2. Press **ENTER**, followed by ◀.
3. Press **ENTER** to finish.

Altitude Display

When the GPS 125 Sounder is acquiring satellites or navigating in the 2D mode, the last known altitude will be used to compute your position. If the altitude shown is off by several hundred feet, you can manually enter your altitude for greater accuracy. Note that GPS altitudes can fluctuate due to errors.

To enter an altitude:

1. Press the ▼ key until the altitude field is highlighted and press **ENTER**.
2. Use the arrow keypad to enter the altitude and press **ENTER**.

Marking & Saving Waypoints

Marking and Saving Waypoints

Knowing your present position is only part of any navigation equation. You also need to keep track of where you've been and where you are going. Waypoints serve as electronic markers that let you keep track of starting points, destinations, nav aids and any other important position.

The GPS 125 Sounder allows you to mark, store and use up to 250 waypoints. A waypoint position can be entered by taking an instant electronic fix, by manually entering coordinates, or by entering range and bearing in reference to an existing waypoint. If you try to mark a waypoint without having a position fix, you'll be notified with a 'No GPS Position' message.

To mark your present position:

1. Press the **MARK** key to capture your position.

The mark position page will appear, showing the captured position and a default 3-digit waypoint name.

To change the default position name:

1. Press the **▼** key once to move the field highlight from the 'SAVE?' field to the name field.
2. Press **ENTER** to clear any existing data and begin entry of the name.
3. Use the arrow keypad to enter the name.
4. Press **ENTER** to confirm the waypoint name. The field highlight will move to the "comment" field.

If you'd like to add this waypoint to a route:

1. Press **▼** once to highlight the route field and press the **ENTER** key.
2. Use the **▲** or **▼** keys to enter a route number and press **ENTER**.
3. Press the **ENTER** key again to save the waypoint.

If you do not want to add this waypoint to a route:

1. Highlight the 'SAVE?' field and press the **ENTER** key.

GPS POSITION
Waypoint:
001
N 36°42.115'
W074°29.032'
DEPTH - 44 FT
Add to route
number: --
SAVE?

The GPS 125 Sounder will automatically name new waypoints with a default three-digit name, with the current digital depth as the default comment. You may then highlight either field, press **ENTER**, and enter your own name or comment.

GPS POSITION
Waypoint:
001
N 36°42.115'
W074°29.032'
DEPTH - 44 FT
Add to route
number: 01
SAVE?

To add a waypoint to a route as you are marking its position, enter the desired route number, highlight 'SAVE?' and press **ENTER**.

Nearest Waypoints Page

MENU
NEAREST HPTS
WAYPOINT LIST
WAYPOINT
ROUTES
DIST AND SUN
TRACK LOG
INTERFACE
SYSTEM SETUP
NAV SETUP
MAP SETUP
ALARMS SETUP
SOUNDER SETUP

To select a waypoint submenu, highlight the desired option and press ENTER.

NEAREST HPTS		
WAYPNT	BRG	DST
DOCK	313°	0.00
FISH-1	019°	1.40
FISH-2	056°	3.18
DRPOFF	085°	3.27
FUEL	139°	4.10
BRUSH	128°	6.19
----	----	----
----	----	----
----	----	----

The compass heading (BRG) and distance (DST) to the nine nearest waypoints are updated continuously.

Waypoint Submenus

The GPS 125 Sounder has three waypoint submenu pages that let you manage a large number of waypoints quickly and efficiently. The nearest waypoints, waypoint list and waypoint definition pages are accessed through the Menu Page.

To select a waypoint submenu page:

1. Press **PAGE** or **QUIT** until the Menu Page appears.
2. Use the **▲** and **▼** keys to highlight the waypoint submenu page you want to use.
3. Press **ENTER** to display the submenu page.
4. To return to the Menu Page, press the **PAGE** key.

Nearest Waypoints Page

The nearest waypoints page shows the nine nearest waypoints that are within 100 miles of your present position, with the bearing and range noted for each waypoint. During an emergency, the nearest waypoints page can give you the closest points of safety in your area at a glance.

The nearest waypoints page will also let you retrieve a waypoint definition page or go to a selected waypoint right from the list.

To review the waypoint definition page of a highlighted waypoint from the list:

1. Press the **ENTER** key.

To return to the nearest waypoint page (when the 'DONE?' field is highlighted):

1. Press the **ENTER** key.

To go to a highlighted list waypoint:

1. Use the **▲** and **▼** keys to highlight a listed waypoint.
2. To select a highlighted nearest waypoint as a destination, press the **GOTO** key.
3. Once the GOTO waypoint page appears, press the **ENTER** key to confirm the selected waypoint as your destination.

Waypoint List Page

Waypoint List Page

The waypoint list page provides you with a complete list of all waypoints currently stored in the GPS 125 Sounder. The total number of used and empty waypoints is indicated above the waypoint list. From the waypoint list page, you can retrieve a waypoint definition page, delete all user-defined waypoints, or go to a selected waypoint. If a waypoint is currently used in a route, the lowest route number will be indicated to the left of the waypoint name.

To review the waypoint definition page of a highlighted list waypoint:

1. Press the **ENTER** key.

To return to the waypoint list page (ensure 'DONE?' is highlighted):

1. Press the **ENTER** key.

To go to a list waypoint:

1. Use the **▲** and **▼** keys to scroll through the list and select a waypoint.
2. To select a highlighted waypoint as a destination, press the **GOTO** key.
3. Once the GOTO waypoint page appears, press the **ENTER** key to confirm the selected waypoint as your destination.

To delete all user-defined waypoints:

1. Use the **▲** or **▼** keys to move the cursor highlight to the 'DEL ALL WPTS?' field.
2. Press the **ENTER** key.

A warning page will appear, asking if you are sure you want to delete all user-defined waypoints and routes. If you want to continue and delete:

1. Press the **◀** key to highlight the 'Yes?' field.
2. Press the **ENTER** key.
3. Press the **QUIT** key to return to the Menu Page.

If you do not want to delete all waypoints:

1. Highlight 'No?' and press **ENTER**.

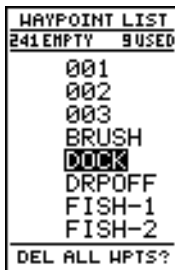

The total number of used and available waypoints is indicated at the top of the page. Route waypoints are indicated by an 'R_'. Above, R03 means route 3.



Deleting all user waypoints will also delete all routes stored in memory.

Waypoint Definition Page

WAYPOINT	
NAME: DRPOFF	
N 39°00.000'	
W095°00.000'	
DEPTH - 43 FT	
REF: -----	
BRG	DST
000°	0.00%
RENAME?	NEW?
DELETE?	DONE?

Use the waypoint definition page to review, rename, or delete stored waypoints and to create new waypoints manually.

WAYPOINT	
NAME: []	

REF: -----	
BRG	DST
-----	-----
RENAME?	NEW?
DELETE?	DONE?

To create a new waypoint by manually entering coordinates or by referencing an existing waypoint, highlight the 'NEW?' prompt and press the ENTER key.

Waypoint Definition Page

The last of the three waypoint management pages is the waypoint definition page. This page lets you create new waypoints manually, or review and edit existing waypoints.

WAYPOINT		
Waypoint Name	NAME: DOCK	Position Coordinates
	N 38°59.382'	
	W094°59.971'	
	26-FEB-97 22:28	Waypoint Comment
Reference Waypoint	REF: -----	
	BRG	DST
Bearing from Reference Waypoint	174°	0.62%
	RENAME?	NEW?
	DELETE?	DONE?
		Distance from Reference Waypoint
		Function Prompts

To create a new waypoint manually, you'll need to know its position coordinates or its distance and bearing from an existing waypoint.

To create a waypoint by entering coordinates:

1. If a waypoint is currently displayed in the name field, highlight 'NEW?' and press **ENTER**. Then press the **◀** key to clear the name field.
2. If a waypoint is not displayed, move the cursor to the name field and enter the new waypoint's name.
3. Use **▲** and **▼** to enter your waypoint name and use **◀** and **▶** to move to the next character position.
4. Press **ENTER** to confirm the waypoint name. The position field will now become highlighted, with the receiver's last known position shown, if one exists.
5. Press **ENTER** to begin entry of the position.
6. Use the **▲** and **▼** keys to enter your position, and use the **◀** and **▶** keys to move to each character field.
7. Press **ENTER** to confirm and save your coordinates. The default waypoint comment (UTC date and time of creation) will appear, and the highlight will move to 'DONE?'.
8. Press the **ENTER** key to return to the Menu Page.

Reference Waypoints

To create a new waypoint manually without knowing its position coordinates, you'll need to enter its bearing and distance from an existing waypoint. The GPS 125 Sounder will then calculate the position coordinates for you.

WAYPOINT	
NAME:	STUMP
N	39°00.000'
W	095°00.000'

REF:	DOCK
BRG	DST
354°	0.62m
RENAME?	NEW?
DELETE?	DONE?

To create a new waypoint by referencing a stored waypoint:

1. Press **▲** until the 'NEW?' field is highlighted.
2. Press **ENTER**.
3. Enter the name of your new waypoint.
4. Press the **ENTER** key to confirm the waypoint name.
The position field will now become highlighted, with the receiver's last known position shown.
5. Press **▼** to move the cursor to the reference field.
6. Press **ENTER** to begin entry of the reference waypoint.
7. Use the arrow keypad to enter the waypoint name.
8. Press the **ENTER** key to confirm your entry.
9. Enter the bearing and distance of your new waypoint from the reference waypoint. Remember to use the **ENTER** key to begin entry and confirm each field. The coordinates will be calculated and saved for your new waypoint.
10. Press the **ENTER** key (with the 'DONE?' field highlighted) to return to the Menu Page.

REFERENCE

Reference Waypoints

WAYPOINT	
NAME:	DOCK
N	39°00.000'
W	094°59.769'
SLIP 12A	

REF:	-----
BRG	DST
086°	00.0m
RENAME?	NEW?
DELETE?	DONE?

The GPS 125 Sounder's advanced waypoint and planning features allow you to create new waypoints and practice navigation without ever leaving the slip.

If you create a new waypoint by entering coordinates from a map, you may want to re-mark the waypoint's exact position once you get there. To re-define an existing waypoint's position coordinates from the waypoint definition page, simply highlight the 'DST' field and press ENTER. Use the LEFT arrow key to set the distance to 0.00, and press ENTER to confirm.

The old coordinates will be replaced by the coordinates of your present position (you must have a valid 2D or 3D position fix).

Editing, Deleting, & Renaming Waypoints

WAYPOINT	
NAME: DOCK	
N 39°00.000'	
W094°59.769'	
---SLIP_12A---	
REF: -----	
BRG	DST
086°	0.18%
RENAME?	NEW?
DELETE?	DONE?

The waypoint comment field will automatically display the date and time of creation of the waypoint. You may replace this with a 16-character custom comment at any time.

WAYPOINT	
NAME: DOCK	
N 39°00.000'	
W094°59.769'	
SLIP 12A	
REF: -----	
BRG	DST
086°	0.18%
RENAME?	NEW?
DELETE?	DONE?

To access the rename function from the waypoint definition page, highlight the 'RENAME?' prompt and press ENTER.

Editing Existing Waypoints

The waypoint definition page also allows you to change the name, coordinates, comment or reference waypoint field for a stored waypoint. (Fields shown on pg. 24.)

To edit the name, coordinates, comment, or reference waypoint field:

1. Use ▲ and ▼ to highlight the field you want to edit.
2. Press **ENTER** to begin entry in the selected field.
3. Enter your new data.
4. Press the **ENTER** key to confirm your changes.

Waypoint Comments

Each waypoint stored in the GPS 125 Sounder has a user-defined 16-character comment field. The default comment is the UTC date and time of the waypoint's creation.

To change or add a comment:

1. Use the ▲ and ▼ keys to highlight the comment field.
2. Press **ENTER** to begin entry of your comment.
3. Enter the comment and press the **ENTER** key to confirm.

Renaming and Deleting Waypoints

RENAME WAYPNT
From
001
To:
DRPOF
Are you sure Yes? or No?

The rename and delete function fields are located at the bottom left of the waypoint definition page (you'll need to use the ◀ key to move the field highlight out of its standard up-and-down scrolling sequence).

Editing and Scanning Waypoints

To rename a stored waypoint:

1. Highlight the 'RENAME?' field and press **ENTER**.
2. Enter the new waypoint name and press **ENTER**.
3. Press the **ENTER** key to confirm your changes.

To delete a stored waypoint:

WAYPOINT	
NAME: FISH-3	
N 37°30.715'	
W048°20.048'	
23-FEB-97 00:18	
REF: _____	
BRG	DST
107°	1.63%
RENAME?	NEW?
DELETE?	DONE?

1. Highlight the 'DELETE?' field and press **ENTER**.
2. Press the **◀** key to select the 'YES' prompt.
3. Press **ENTER** to delete the waypoint.

Scanning Waypoints

As you manually enter a waypoint's name, the GPS 125 Sounder's waypoint scanning feature will automatically display the first numerical or alphabetical match of the character you have entered to that point. This helps eliminate the need to always enter a waypoint's complete name.

To scan waypoints from a waypoint field:

1. Highlight the waypoint name field and press **ENTER**.
2. Press the **◀** key to clear the name field.
3. Use the **▲** and **▼** keys to scroll through waypoints.
4. If you have more than one waypoint that begins with the same letter or number, you must use the **▶** key to move to the next character positions as needed. Only the first character match is listed for each character set.
5. Once you've found the desired waypoint, press **ENTER**.

DELETE WAYPT
WARNING!
FISH-7
will be deleted
Are you sure
Yes? or No?

A warning page will ask you for confirmation to delete the selected waypoint.

Note: If a waypoint is part of a route, you will need to remove it from the route before it can be deleted. (See pg. 36)

WAYPOINT	
NAME: D OCK_	
N 39°00.000'	
W094°59.763'	
SLIP 12A	
REF: _____	
BRG	DST
086°	0.18%
RENAME?	NEW?
DELETE?	DONE?

Waypoint names will appear alphabetically when scanning waypoints. If two waypoints begin with the same letter(s) you must move the cursor to the first letter they do not have in common for them to appear.

Starting/Stopping a GOTO & MOB

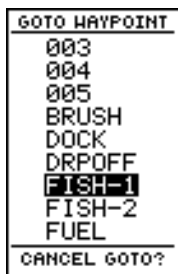

Select a destination waypoint from the GOTO waypoint list.

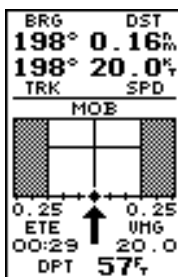

Once the MOB mode has been activated, steering guidance will be provided by the Highway or Compass Page. Activating another MOB will replace the previous MOB waypoint.

Selecting a GOTO Destination

The GPS 125 Sounder provides four ways to navigate to a destination: GOTO, MOB, TracBack and route navigation. The most basic method of selecting a destination is the GOTO function, which lets you choose any stored waypoint as the destination and quickly sets a direct course from your present position.

To activate the GOTO function:

1. Press the **GOTO** key. The GOTO waypoint list, an alphabetical list of all available waypoints, will appear.
2. Use the **▲** and **▼** keys to select the waypoint you want to navigate to (it may already be highlighted).
3. Press the **ENTER** key to confirm, or **QUIT** to stop selection of a GOTO destination and return to the previous page.

Once a GOTO waypoint has been activated, the Compass Page or Highway Page will provide steering guidance to the destination until either the GOTO is cancelled or the unit has resumed navigating the active route (see pg. 36).

To cancel an active GOTO:

1. Press the **GOTO** key.
2. Use the arrow keypad to move the field highlight to the 'CANCEL GOTO?' prompt at the bottom of the page and press **ENTER**.

Man Overboard Function

The GPS 125 Sounder's man overboard function (MOB) lets you simultaneously mark and set a course to a position for quick response to passing positions (like the spot where your hat blew overboard).

To activate the MOB mode:

1. Press the **MOB** key. The GOTO waypoint page will appear with 'MOB' selected as the default destination.
2. Press the **ENTER** key to begin MOB navigation.

The GPS 125 Sounder will now guide you to the MOB waypoint until the MOB GOTO is cancelled (see "to cancel an active GOTO" above). If you want to save the MOB waypoint, be sure to rename it, because it will be overwritten the next time a MOB is executed.

TracBack Navigation

TracBack Navigation

The third method of navigating to a destination is by using the GPS 125 Sounder's TracBack feature. The TracBack function allows you to quickly and easily retrace your path using the track log automatically stored in the receiver's memory. The advantage of the TracBack feature is to eliminate the need to mark waypoints along the way and manually create and activate a route back to where you began your trip.

The TracBack route is created by reducing your current track log into a route of up to 30 waypoints, and activating an inverted route along those points. Once activated, a TracBack route will lead you back to the oldest track log point stored in memory, so it's usually a good idea to clear the existing track log at the starting point of your current trip (e.g. your car or the dock) *before* you get started.

To clear the track log and define a starting point for a TracBack route:

1. From the Menu Page, highlight 'TRACK LOG'.
2. Press **ENTER** to access the track log page.
3. Use the **▲** key to highlight the 'CLEAR LOG?' option.
4. Press **ENTER**. A confirmation page will appear.
5. Use **◀** to highlight the 'Yes?' prompt and press **ENTER**.

To activate a TracBack route:

1. From the Menu Page, highlight 'TRACK LOG' option.
2. Press **ENTER** to access the track log page.
3. Highlight the 'TRACBACK?' option and press **ENTER**.

Once the TracBack function has been activated, the GPS 125 Sounder will take the track log currently stored in memory and divide it into segments called legs. Up to 30 temporary waypoints (e.g., 'T001') will be created to mark the most significant features of the track log in order to duplicate your exact path as closely as possible. A TracBack route from your present position to the oldest track log point will be created as an active route (the active route page will appear), and provide steering guidance to each waypoint back to the starting point of your track log.

TRACK LOG	
RECORD:	Yes
CRITERIA:	Automatic
MEMORY USED	
1 of 762 points (0%)	
CLEAR LOG?	TRACBACK?

Clearing the log before you get started will define the position the TracBack function will return you to.

TRACK LOG	
RECORD:	Yes
CRITERIA:	Automatic
MEMORY USED	
1 of 762 points (0%)	
CLEAR LOG?	TRACBACK?

Highlight 'TRACBACK?' and press ENTER to begin TracBack navigation.

TracBack Navigation

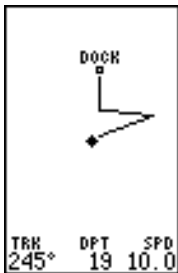

The TracBack feature will navigate your track log back to the oldest point in the receiver's memory.

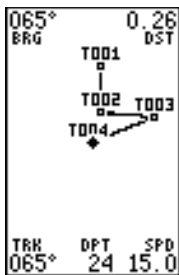

The track log will be divided into segments with temporary waypoints to create a route back to the beginning of the track log.

Tips on Creating and Using the TracBack Feature

The GPS 125 Sounder's TracBack feature is designed to help you quickly create and activate a route that follows your path back to a user-defined starting point. To get the most out of the TracBack feature, remember the following tips:

- Always clear your track log at the exact point that you want to return to (truck, dock, etc.).
- The 'RECORD' option on the track log setup page must be set to the 'Yes' position.
- There must be at least two track log points stored in memory to create a TracBack route.
- If there are not enough available waypoints in memory to create a TracBack route, you will be alerted with a 'waypoint memory full' message, and the receiver will use any available waypoints to create a TracBack route with an emphasis on the track log closest to the destination (the oldest track log point in memory).
- If the 'CRITERIA' option on the track log setup page is set to a time interval, the TracBack route may not follow your exact path (the 'Automatic' setting will provide the best TracBack route).
- If the receiver is turned off or you lose satellite coverage during your trip, the TracBack route will simply draw a straight line between any point where coverage was lost and where it resumed.
- If the changes of direction and distance of your track log are very complex, 30 waypoints may not be enough to accurately mark your exact path. The receiver will then assign the 30 waypoints to the most significant points of your track.
- If you want to save a TracBack route, copy route 0 to an open storage route before activating another TracBack. Activating another TracBack or storage route will overwrite the existing TracBack route.
- Whenever a TracBack route is activated, temporary waypoints (e.g., 'T001') that are not contained in routes 1-19 are erased. If there are temporary waypoints stored in routes 1-19, the receiver will create any new temporary waypoints using the first three-digit number available.

Creating and Navigating Routes

The last form of navigating to a destination with the GPS 125 Sounder is by creating a user-defined route. The route navigation feature lets you plan and navigate a course from one place to another using a set of pre-defined waypoints. Routes are often used when it's not practical, safe, or possible to navigate a direct course to a particular destination (e.g., through a body of water or impassable terrain).

Routes are broken down and navigated in smaller segments called "legs". The waypoint you are going to in a leg is called the "active to" waypoint, and the waypoint immediately behind you is called the "active from" waypoint. The line between the "active to" and the "active from" waypoint is called the "active leg".

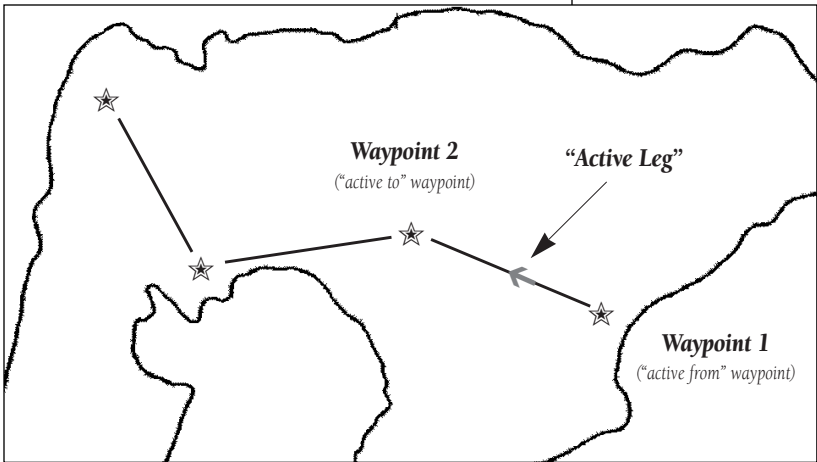

Whenever you activate a route with the GPS 125 Sounder, it will automatically select the route leg closest to your position as the active leg. As you pass each waypoint in the route, the receiver will automatically sequence and select the next waypoint as the "active to" waypoint.

Route Definition Page

GPS POSITION
Waypoint: FISH-5
N 37°20.694'
W046°50.072'
DEPTH - 34 FT
Add to route number: 4
SAVE?

If you're heading out without a planned route, the mark function can be used to quickly create a route back to your starting point.

Create a series of waypoints along the way with the MARK key and save them to an open route from the mark position page. When you're ready to head back, simply activate the route you created in inverted order (see pg. 34).

Route Definition Page

The GPS 125 Sounder lets you create and store up to 20 routes of 30 waypoints each. Routes are created, copied, and edited through the route definition page, which is accessed through the Menu Page.

Comment Field	ROUTE: 4	Route Number
	DOCK TO DRPOFF	
Desired Track of Leg	NO WAYPNT DTR DST	Leg Distance
	1 DOCK 019' 1.4	
	2 FISH-1 078' 2.2	
	3 FISH-2 158' 6.1	
	4 BRUSH 339' 4.4	
	5 DRPOFF --- --	
	6 --- --	
	TOTAL DST 14.1	Total Route Distance
Copy Field	COPY TO: --	
	CLR? INU? ACT?	Function Prompts

To select the route definition page:

1. Press **PAGE** until the Menu Page appears.
2. Use the **▲** and **▼** keys to highlight the 'ROUTES' option.
3. Press the **ENTER** key to display the route definition page.
4. To return to the Menu Page, press **PAGE**.

The route number field is displayed at the top of the page, with a 16-character user comment below. If no user comment is entered, the field will display the first and last waypoint in the route. The waypoint list in the middle of the page accepts up to 30 waypoints for each route, with fields for desired track and distance between legs. The total distance of the route is indicated below the waypoint list.

The bottom of the route definition page features several function fields which let you copy, clear, invert, or activate the displayed route. Routes 1-19 are used as storage routes, with route 0 always serving as the active route you are navigating. If you want to save a route currently in route 0, be sure to copy it to another open route, as it will be overwritten by the next route activation.

Creating, Copying, & Clearing Routes

To create a route from the route definition page:

1. Highlight the route number field and press **ENTER**.
2. Enter a route number and press the **ENTER** key to confirm.
3. Press **ENTER** to begin entry of a route comment. (Note that the default [first and last waypoint] comment will only appear if the comment field is blank.)
4. Enter your comment and press the **ENTER** key.
5. Highlight the No. 1 waypoint field and press **ENTER**.
6. Enter the first waypoint of your route and press **ENTER**.
7. Continue entering the rest of your waypoints in order, using the **ENTER** key to start and confirm each field entry. The list will automatically scroll down.
8. After you have entered all your waypoints, press **PAGE**.

Copying and Clearing Routes

The route definition page is also used to copy a route to another route number. This feature is useful when you make changes to the active (or TracBack) route and want to save the route for future use.

To copy a route:

1. Highlight the route number field and press **ENTER**.
2. Enter the route number to be copied and press **ENTER**.
3. Highlight the 'COPY TO' field and press **ENTER**.
4. Scroll through the available routes and select a destination route number. Only open routes will be available as choices. Press the **ENTER** key to copy the route.
5. Press the **PAGE** key to return to the Menu Page.

To clear a route from memory:

1. Highlight the route number field and press **ENTER**.
2. Enter the route number and press **ENTER**.
3. Select the 'CLR?' prompt and press **ENTER**.

ROUTE: 12			
NO	WAYPNT	DTR	DST
1	FISH-1		
2	-----		
3	-----		
4	-----		
5	-----		
6	-----		
TOTAL DST			0.00
COPY TO: --			
CLR? INU? ACT?			

Enter each waypoint in the order you would like to navigate them. If you enter a waypoint not stored in memory, you'll need to define the position on the waypoint definition page.

ROUTE: 4			
DOCK TO DRPOFF			
NO	WAYPNT	DTR	DST
1	DOCK	019'	1.4
2	FISH-1	078'	2.2
3	FISH-2	158'	6.1
4	BRUSH	339'	4.4
5	DRPOFF		
6	-----		
TOTAL DST			14.1
COPY TO: 4?			
CLR? INU? ACT?			

To copy a route, select an open storage route and press the **ENTER** key. If you select a route that is already used, you'll be alerted with a 'Route Full' Message.

Clearing, Activating, and Inverting Routes

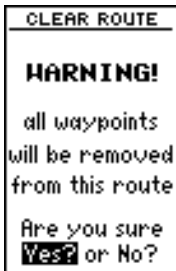

Clearing a route only removes the waypoints from the route selected. The waypoints used for the route will still remain in memory individually.

ROUTE: 4			
DOCK TO DRPOFF			
NO	WAYPNT	DTH	DST
1	DOCK	019'	1.4
2	FISH-1	078'	2.2
3	FISH-2	158'	6.1
4	BRUSH	339'	4.4
5	DRPOFF	---	---
6	-----	---	---
TOTAL DST			14.1
COPY TO: --			
CLR? INU? ACT?			

To activate a route, highlight the 'ACT?' prompt and press ENTER.

Clearing Routes (continued)

The clear route warning will appear, asking you to confirm that you want to remove all waypoints from the route.

1. Highlight the 'Yes?' field with the ◀ key.
2. Press **ENTER** to confirm your action.
3. Press **PAGE** to return to the Menu Page.

Activating and Inverting Routes

After a route has been entered, it can be activated in its defined sequence or inverted from the route definition page. The process of activating or inverting a stored route takes a storage route (routes 1-19) and copies it into the active route (route 0) for navigation. The storage route is now no longer needed and will be retained in its original format under its existing route number.

This system allows you to have an active route that you may edit during navigation and save as an entirely new route from the original. You will have to copy the active route to an unused storage route to save it, since new route or TracBack activation overwrites route 0.

To activate a route:

1. Select the route definition page and press the **ENTER** key to activate the route number field.
2. Enter the route number to be activated and press **ENTER**.
3. Move the field highlight to the 'ACT?' prompt and press the **ENTER** key.

Inverting a route allows you to navigate route legs in reverse order without editing the original route.

To activate a route in inverted order:

1. Follow the steps above, but select the 'INV?' prompt and press **ENTER**.

Active Route Page

Active Route Page

Once a route has been activated, the active route page will appear, displaying the waypoint sequence of your route with the estimated time enroute (ETE) at your present speed and distance to each waypoint. As long as you are navigating an active route, the active route page will become part of the primary page sequence of the unit.

The active route page will also allow you to change the ETE field to display desired track (DTK) or estimated time of arrival (ETA) for each leg. In addition, you can also clear or invert the active route.

To display DTK or ETA for each leg:

1. Highlight the estimated time enroute (ETE) field and press the **ENTER** key.
2. Use the **▲** or **▼** keys to select 'DTK' or 'ETA' and press the **ENTER** key.

The active route page also allows you to clear (stop navigating) or invert the active route without using the route definition page.

To invert a route from the active route page:

1. Press the **▲** key once to move the field highlight to the 'INVERT?' prompt.
2. Press the **ENTER** key to invert the route.

To clear the active route from the active route page and stop route navigation:

1. Use the **▲** and **◀** keys to select the 'CLEAR?' prompt.
2. Press the **ENTER** key to clear the active route.

Editing Routes

Once a route has been created and stored, it can be edited at any time, even if it is the active route.

To edit a route from the active route page or the route definition page:

1. Use the **▲** and **▼** keys to select the waypoint you want to edit and press **ENTER**.

ACTIVE ROUTE		
DOCK TO DRPOFF		
WAYPNT	ETE	DST
DOCK	--:--	----
FISH-1	04:05	0.84
FISH-2	14:54	3.05
BRUSH	44:27	9.11
DRPOFF	01:06	13.5
-----	----	----
-----	----	----
CLEAR? INVERT?		

Whenever you have activated a route, the active route page will appear in the primary page sequence after the Highway/Compass Page.

ACTIVE ROUTE		
DOCK TO DRPOFF		
WAYPNT	ETE	DST
DOCK	--:--	----
FISH-1	03:46	0.77
FISH-2	14:35	2.99
BRUSH	44:08	9.05
DRPOFF	01:06	13.4
-----	----	----
-----	----	----
CLEAR? INVERT?		

To edit or review a route waypoints from the active route page, highlight the desired waypoint and press **ENTER**.

**Editing Routes &
On-Route
GOTO's**



Use the on-screen menu to select the desired editing function.

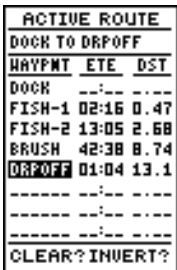

You can skip ahead and navigate to any route waypoint by highlighting the desired waypoint and pressing the GOTO key.

Editing Routes (continued)

An on-screen menu of editing choices will appear, with options for reviewing, inserting, deleting, or changing the waypoint field highlighted. Use the ▲ and ▼ arrow keys to select among the editing choices.

Once you've selected a waypoint from the route list, choose a menu function:

1. To review the definition page for the waypoint, highlight the 'REVIEW?' prompt and press **ENTER**.
2. To add a new waypoint preceding the selected waypoint, highlight the 'INSERT?' prompt and press **ENTER**.
3. To remove the selected waypoint, highlight the 'REMOVE?' prompt and press the **ENTER** key.
4. To replace the selected waypoint with a new waypoint, highlight the 'CHANGE?' prompt and press **ENTER**.

Use the route waypoint editing instructions described earlier for creating a route to complete your changes. If you are editing the active route (route 0), copy your new route version to an empty route to save it, because the active route will be overwritten by a new route activation.

If you add, delete, or change the first or last waypoint of a route, the default comment (first and last waypoint) will automatically be updated.

On-Route GOTOs

At the beginning of this section, we mentioned that the GPS 125 Sounder will automatically select the route leg closest to your position as the active leg. This will give you steering guidance to the desired track of the active leg. If you would prefer to steer directly to a route waypoint, you can perform an "on-route GOTO" from the active route page.

1. Use the ▲ and ▼ keys to highlight the desired route waypoint and press the **GOTO** key.
2. Once the GOTO waypoint page appears, press **ENTER** to confirm.

Note that after you reach the on-route GOTO waypoint, the GPS 125 Sounder will automatically resume navigating the rest of the route in sequence.

Sounder Page

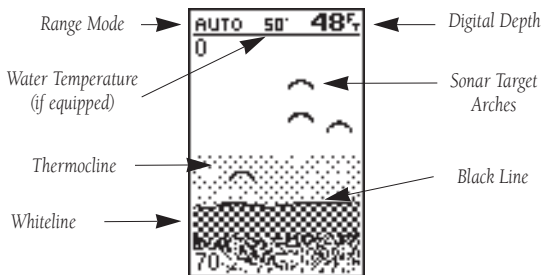

The Sounder Page lets you use the GPS 125 as a fishfinder. The top of the screen shows the range mode being used, the water temperature (if using a temperature-sensitive transducer), and the digital depth, while the middle of the page contains a right-to-left moving sonar image of the water beneath your boat. (Note: items appear as they pass under your transducer. Those objects appearing on the right side of the screen are closer to you than those objects on the left.) **Fish** are displayed as a darkened arch or a fish icon in three different sizes. **Thermoclines** (layers of water separating warmer water above and cooler water below) appear as dotted patterns just above the bottom.

The area of strongest sonar return (**whiteline**) is displayed as a mix of light and dark checkering. Typically, the bottom will be the primary source of the whiteline. A thin whiteline indicates a softer bottom while a thicker whiteline shows a harder bottom. A **black line** is used to show the point where water meets the whiteline. This black line will follow the bottom contour, along with any significant objects lying on the bottom. Along the left side of the screen (typically) is an **adjustable scale** which shows the current display's range of depth.

Range Modes

The GPS 125 Sounder uses two range modes: auto and manual. '**Auto**' displays the most information possible while continuously displaying the bottom. '**Manual**' lets you select the displayed range. You may switch between auto and manual modes by using the arrow keypad or by using the sounder setup menu.

REFERENCE

Sounder Page Overview & Range Modes



GARMIN's exclusive See-Thru technology will allow you to distinguish sonar targets from bottom clutter and thermoclines.

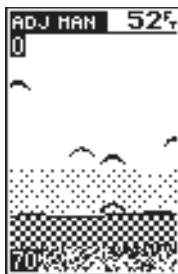

The GPS 125 Sounder uses Depth Controlled Gain (DCG) to give you the maximum amount of information possible with minimal distortion.

Range Modes & Underwater Waypoints

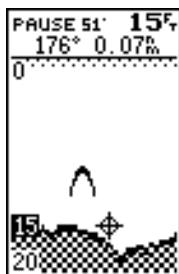

Use the target cursor to mark the desired underwater location.

Note: The bearing and range shown are to the cursor's location from your present position.

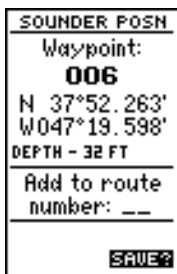

The underwater waypoint will be marked using the sounder position.

The default comment will be the cursor's depth.

To switch from auto to manual mode:

1. Press the ▲ or ▼ keys until the desired depth range is displayed on the depth scale at the left side of the page.
2. Press **ENTER** to confirm the selected range.

To switch from manual to auto mode:

1. Press the arrow keypad up or down until you hear a repeated beep. 'Auto' will be displayed in the range field at the top left corner of the screen.
2. Press **ENTER**.

Underwater Waypoint Feature

The underwater waypoint feature marks a waypoint's position and its depth. This makes it easier to find and use an object such as a stump for a future fishing location. The target's depth will be shown on the left or right side of the screen depending on the location of the cursor, and will move up and down as the cursor moves.

To mark an underwater waypoint:

1. Press **ENTER** to pause the screen movement.
2. Use the arrow keypad to activate and move the cursor onto the desired target (underwater drop off, stump, etc.). A data field will appear, showing the distance and bearing from your position. Since the distance and bearing shown are measured from the boat to the waypoint, they will change as your boat moves, even if the cursor is stationary.

Note: The cursor will not move off the paused display and cannot show an area that has scrolled off the screen.

3. Press **ENTER**. A page will appear with the waypoint's coordinates, default three digit name, and depth.
4. Enter any waypoint information such as name, comment, etc., and press **ENTER**. Note: the waypoint's depth is the default comment. It is possible for a custom comment to type over this number.
5. When finished, highlight 'SAVE?' and press **ENTER**. The Sounder Page will reappear.
6. To resume screen movement, press **QUIT**.

Zoom Function & Zoom Window

Zoom Function

The sounder zoom function allows you to see the current display picture at 2 times (2X) or 4 times (4X) magnification. 2X means that the screen displayed will now cover 1/2 the range you were originally viewing in twice the detail, and 4X shows 1/4 the original range at four times the detail. Because less area is being shown (in a zoom screen) objects can be seen in greater detail.

The zoom function is accessed by using the IN and OUT key when viewing the Sounder Page. The sounder zoom function is divided into two display levels:

- 2X - Displays the zoomed screen at 1/2 the original range.
- 4X - Displays the zoomed screen at 1/4 the original range.

Once activated, the zoomed picture becomes the Sounder Page display. Note: The zoom function can only be deactivated by pressing the OUT key until the original zoom scale appears.

The zoom function operates in either Auto range or Manual range. Zooming while in Auto will continue to follow the bottom contour, while zooming in Manual will show the selected depth.

To access the sounder zoom function:

1. While viewing the Sounder Page, press **IN** once. The 2X screen will appear. Note: the current zoom scale will be displayed in the upper left corner of the screen.
2. Press **IN** once more to advance to the 4X screen.
3. To deactivate the sounder zoom function, press **IN** once. You may also press and hold **OUT** until the original scale picture appears and a triple beep sounds.

Moving the Zoom Window

You may move the displayed range on a zoomed screen at any time, just as you would a non-zoom screen, by pressing the arrow keypad up or down. This will move the zoom “window”.

If you prefer to keep the window in its new position, you will need to save the change. Note: Saving the new window position requires different steps if you are in Auto range when you move the window versus being in Manual when the window is moved.

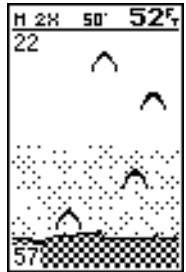

Pressing the IN key once while on the Sounder Page activates the 2X Zoom.

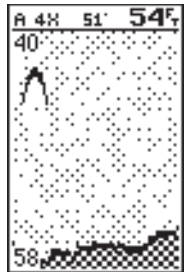

The 4X zoom shows objects at 4 times magnification and 1/4 the original range scale.

Zoom Window

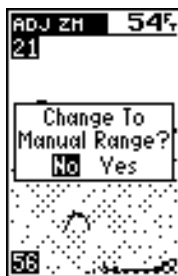

If you activate the zoom while in Auto range mode and then decide to manually adjust the range, a message window will appear. Highlight 'Yes' and press ENTER to activate Manual range mode and continue manually adjusting the range.

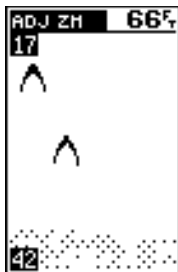

The zoom window may be moved at any time by using the arrow keypad.

To save a zoom window range in Auto:

1. Press the keypad up to view a shallower range or down to view a deeper range. The range scale on the left side of the zoomed picture will be highlighted.
2. When the window reaches the desired range, press to accept. A 'Change To Manual Range?' window will appear. Highlight 'Yes' and press .
3. If you do not want to save the range, highlight 'No' and press . You may then resume manually moving the zoom window.
4. Press at any time to return to an auto range mode display.

To save a zoom window range in Manual:

1. Press the keypad up to view a shallower range or down to view a deeper range. The range scale on the left side of the zoomed picture will be highlighted.
2. When the window reaches the desired range, press to accept.
3. If you do not want to save the range, press to return to the previous window range.

Sounder Setup

The sounder displays can be customized to fit your needs from the sounder setup submenu accessed from the Menu Page (See pg. 58-61).

Map Page

Map Page

The GPS 125 Sounder features a real-time moving map that can do much more than just plot your course and route. The Map Page also provides you with a target cursor that will let you pan ahead to nearby waypoints, determine the distance and bearing to any map position, and mark new waypoints while you navigate.

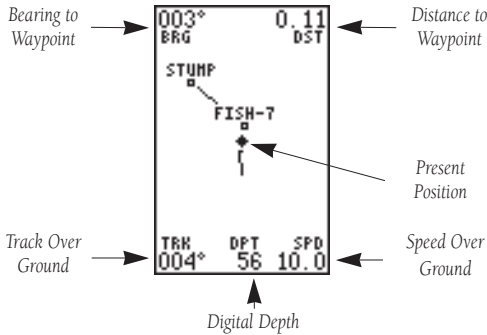

The map contains 12 selectable range scales from 0.2 to 320 miles (0.5 to 600 km). The scale represents the distance shown from the top of the screen to the bottom. Move from scale to scale by using the dedicated zoom keys (IN and OUT). Press IN for a smaller scale map and press OUT for a larger scale map.

A diamond icon in the center of the page represents your present position, with your track and/or route displayed as a solid line. Nearby waypoints are shown as squares, with the corresponding name listed. You may select which items are shown through the map setup submenu page (see pg. 56 for more information).

The four corners of the Map Page are used to display various navigation data, including the bearing and distance to a destination waypoint and your current track and speed over the ground. The two fields at the top corners of the map show your bearing and distance to one of three selectable destinations: an active destination waypoint; a highlighted on-screen waypoint; or the panning target crosshair. If you are not navigating to a waypoint or using the panning function, the top data fields will not be displayed. The bottom corners of the display always show your current track and speed, with the digital depth shown in the center.

The GPS 125 Sounder has on-screen range rings to help you estimate distances relative to your present position. The value of each ring is determined by the current zoom scale, and is equal to 1/5 of the selected scale.

To turn the range rings display on or off (the default setting is OFF) see the map setup instructions on pg. 55-56.

Map Zooming, Panning, & Pointing

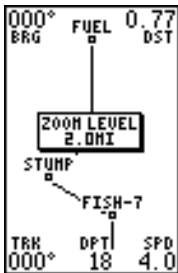

To change the map scale, press the IN or OUT key once for each level desired. An on-screen window will display the current zoom scale.

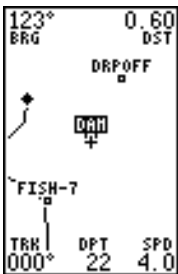

The crosshair will “snap” to waypoints highlighted on the map, which allows you to quickly review or go to the selected waypoint right from the Map Page.

Zooming, Panning, and Pointing

There are three main functions you can perform from the Map Page: zooming, panning, and pointing. Zooming is increasing or decreasing the display scale of the map. Panning is using a target crosshair and the arrow keypad to “slide” your view of the map in any direction, including diagonally, to view the surrounding area. “Pointing” is the act of highlighting a waypoint on the map in order to find out more about the waypoint and conduct a GOTO or highlighting a position on the map to create a new waypoint and conduct a GOTO.

To select a zoom scale (even while panning):

1. Press **IN** or **OUT** once for each level of increase or decrease desired.
2. Press and hold down either key to increase or decrease by more than one scale.

To activate the pan function:

1. Press the arrow keypad in any direction, including diagonally.

As you begin to move the map, a crosshair will appear. This crosshair will now serve as a target marker for the moving map. The distance and bearing from your present position to the target crosshair will appear in the upper corners of the map. If you are conducting a GOTO at the time you activate the panning function, the crosshair bearing and distance will replace the bearing and distance of the GOTO waypoint.

As you pan around the map, you’ll notice that the target crosshair will point to on-screen waypoints and highlight the waypoint name. Once a waypoint name is highlighted, you can review its waypoint definition page or execute a GOTO right from the Map Page.

To review the definition page for a waypoint highlighted on the map:

1. Press **ENTER**. The waypoint definition page will appear. Review and make any desired changes to the highlighted waypoint.
2. When finished, highlight the “DONE?” field and press **ENTER**.

Using the Cursor on the Map

To go to a waypoint highlighted on the map:

1. Press the **GOTO** key. The GOTO waypoint page will appear with the waypoint's name highlighted.
2. Press the **ENTER** key to confirm.

To stop the panning function and display your present position:

1. Press the **QUIT** key.

Using the Cursor to Mark and Go to Waypoints

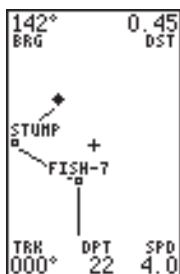

During panning, the crosshair represents a target position right on the moving map, with the range and bearing to the target displayed at the top corners of the screen. You can also use the target crosshair to mark a new waypoint position or as a GOTO destination right from the map field.

To mark the target crosshair position as a new waypoint:

1. Press the **ENTER** key to capture the position.
2. Enter a new name and route number and press **ENTER**.

You can also use the target crosshair as an instant GOTO destination. This function will mark and instantly set a course for a new waypoint called 'MAP'.

To GOTO the target crosshair:

1. Press the **GOTO** key to capture the position.
2. Press the **ENTER** key to confirm the MAP GOTO.

To save the MAP waypoint, rename it, as it will be overwritten the next time a map GOTO is executed.



To mark a waypoint with the crosshair, simply pan to the desired position and press the **ENTER** key.

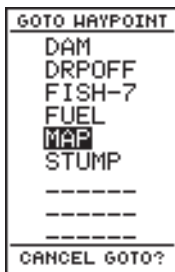

The crosshair may also be used to define a GOTO destination by panning to the desired position and pressing the **GOTO** key. To save the MAP waypoint, rename it, as it will be overwritten by the next MAP waypoint.

Highway & Compass Pages

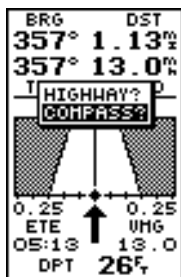

To switch the navigation page to the Compass Page, press ENTER twice.



To switch the navigation page to the Highway Page, press ENTER twice.

Selecting a User-Defined Navigation Page

Once you've selected a GOTO destination or activated a MOB or route, the GPS 125 Sounder will provide graphic steering guidance to the destination with one of two navigation pages:

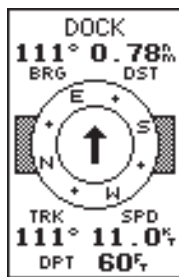
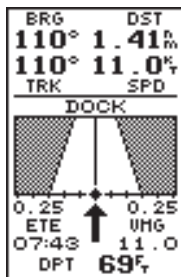

- The Highway Page (the default navigation page) provides a graphic highway that shows your movement relative to the desired course, with an emphasis on your crosstrack error (the distance and direction you are off course). The Highway Page is well-suited for boating and other activities with higher speeds and straight-line courses to a destination.
- The Compass Page provides a directional pointer to the destination, with a rotating compass graphic to display your direction of travel. The Compass Page is ideal for activities like trawling or entering a harbor, and provides better steering guidance for slow-speed (e.g., walking) travel with many directional changes.

Both pages provide a digital display of the bearing and distance to the destination, along with your current speed and track over the ground. Select the desired navigation page at any time.

To select the Compass or Highway Page:

1. Press **PAGE** until the current navigation page appears.
2. Press **ENTER**. An on-screen box will appear, with the navigation page not currently in use highlighted as the default.
3. Press **ENTER** to switch the navigation screen.

Highway Page

Using the Highway Page

The GPS 125 Sounder's Highway Page also provides graphic steering guidance to a destination, with a greater emphasis on the straight-line desired course and the distance and direction you are off course. The bearing and distance to a waypoint--along with your current track and speed--are displayed at the top of the screen, with your digital depth, estimated time enroute (ETE), and velocity made good (VMG, or the rate you are closing in on your destination), at the bottom.

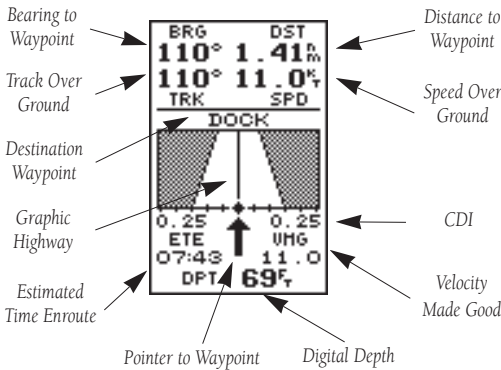

As you head toward your destination, the middle section of the screen provides visual guidance to your waypoint on a moving graphic "highway".

Your present position is represented by the diamond in the center of the course deviation scale. The line down the middle of the highway represents your desired track. As you navigate toward a waypoint, the highway will actually move and indicate the direction you are off course, relative to the position diamond on the CDI scale. To stay on course, simply steer toward the center of the highway.

If you do get off the desired course by more than 1/5th of the selected CDI range, the distance you are off course will be displayed where the CDI scale setting normally appears. If you get too far off course (the highway has disappeared), a message box will appear to indicate what course to steer to get back on course.

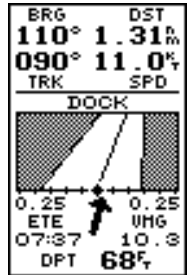

In this example, the Highway Page indicates that you are off course to the left. Steer right to get back on course. Notice the emphasis of the Highway Page is on the desired course.



If you get too far off course, a message box will appear to indicate what course to steer to get back on course most efficiently.

Compass Page

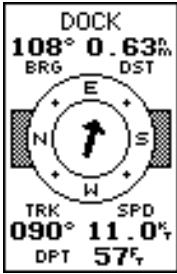

In this example, the Compass Page indicates that you are traveling in an east (090 degrees) direction and the destination waypoint is southeast (108 degrees) of your current direction of travel.

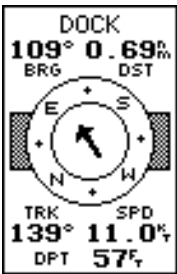

In this example, the Compass Page indicates that you are traveling in a southeast (139 degrees) and the destination waypoint is due east (109 degrees) of your current direction of travel.

Using the Compass Page

The GPS 125 Sounder's Compass Page provides graphic steering guidance to a destination waypoint. The bearing (BRG) and distance (DST) to the waypoint are displayed at the top of the page, below the destination waypoint field. The distance displayed is always the straight-line distance from your present position to the destination waypoint. The bearing indicates the exact compass heading from you to the destination.

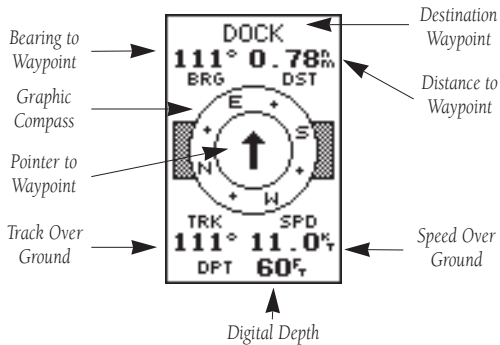

The middle of the page features a rotating “compassing” that shows your current heading while you’re moving (track up), with a pointer arrow to the destination, displayed in the center. The arrow shows the direction of your destination from the direction you are moving. If the arrow points up, you are going directly to the waypoint. If the arrow points any other direction (left, right, down, etc.), turn toward the arrow until it points up and then continue in that direction.

The bottom of the Compass Page shows your current track (TRK), speed (SPD) over the ground, and digital depth (DPT).

When you are one minute away from the destination (based on your current speed and track over the ground), the GPS 125 Sounder will alert you with a flashing on-screen message box.

Menu Page & Distance/Sun Calculation

Menu Page

The GPS 125 Sounder Menu Page provides access to submenu pages used to select and customize operation and navigation setup. The 11 submenus are divided into categories by function. See pg. 21-36 for discussion of waypoint and route management submenus. We'll now address the rest of the submenus in the order they appear on the Menu Page.

To select a submenu page from the Menu Page:

1. Highlight the submenu page you want to view.
2. Press the **ENTER** key to display the submenu page.
3. To return to the Menu Page, press the **QUIT** key.

Distance and Sun Calculation

The distance and sun calculation page will give you the distance and bearing between any two waypoints and will calculate the sunrise and sunset (in local time) at a destination waypoint for a particular date.

To perform a distance and sun calculation:

1. Highlight the 'FROM' field and enter the desired waypoint. Press **ENTER** to move to the next field.
2. Highlight the 'TO' field and enter the destination waypoint. Press the **ENTER** key to calculate the range and bearing to the destination waypoint.
3. Highlight 'DATE' and enter the date for your destination. Press **ENTER** to display the sun information.

Track Log Setup Page

The track log setup page lets you manage the GPS 125 Sounder's tracking data. From this page, you can select whether or not to record a track and define how it is recorded.

To turn the track log on or off:

1. Highlight the 'RECORD' field and press **ENTER**.
2. Select 'Yes' or 'No' and press **ENTER**. NOTE: Turning the track recording off will prevent using TracBack.

MENU
NEAREST WPTS
WAYPOINT LIST
WAYPOINT
ROUTES
DIST AND SUN
TRACK LOG
INTERFACE
SYSTEM SETUP
NAV SETUP
MAP SETUP
ALARMS SETUP
SOUNDER SETUP

To select a submenu, use the UP and DOWN arrow keys to highlight a menu option and press ENTER.

DIST AND SUN
FROM: DOCK
TO: FISH-8
BRG DST
343° 37.1%
DATE: 19 FEB 97
SUNRISE
10:54:37pm
SUNSET
09:51:32am
AT DESTINATION

The GPS 125 Sounder will calculate the sunrise and sunset times of any stored waypoint or your present position. To calculate, enter the date and year and press ENTER.

Track Log Setup & TracBack

TRACK LOG	
RECORD:	No
CRITERIA:	Automatic
MEMORY USED 2 of 762 points (0%)	
CLEAR LOG? TRACBACK?	

Turning the track recording option off will prevent you from using the TracBack option.

TRACK LOG	
RECORD:	Yes
CRITERIA:	Time Interval: 00:00:30
MEMORY USED 6 of 762 points (0%)	
CLEAR LOG? TRACBACK?	

Entering a time interval in to the track recording criteria will plot your position points further apart than they would be in the 'Automatic' setting. This will increase the distance you can travel without using up your track log, but will greatly reduce the effectiveness of TracBack.

Track Criteria

The stored track criteria determines how often positions are stored in the track log. The default setting is automatic, which stores track based on resolution. 'Automatic' is the most efficient use of track memory and provides the most accurate TracBack route.

To change the criteria to record points based upon a specific time interval:

1. Highlight the 'CRITERIA' field and press **ENTER**.
2. Use **▲** or **▼** to select 'Time Interval' and press **ENTER**.
3. Press **ENTER** to begin entry of the interval.
4. Enter a value in hours, minutes and seconds, and press the **ENTER** key.

Managing and Clearing the Track Log

The rest of the track log setup page displays the percentage of available memory currently used to store track log data and function fields in order to clear the track log memory and activate the TracBack feature.

To clear the track log:

1. Highlight 'CLEAR LOG?' and press **ENTER**.
2. A warning page will appear, and ask you to confirm your actions. Use the **◀** key to move the field highlight to the 'Yes?' field and press **ENTER**.

TracBack Function

The TracBack option lets you activate a TracBack route using the track log (see pg. 29-30 for more information).

To activate a TracBack route:

1. Highlight the 'TRACBACK?' option and press **ENTER**.

Interface Options

Interface Setup

The interface setup page lets you specify the interfacing formats for connecting external devices. There are five interface options: GRMN/GRMN, None/None, None/NMEA, RTCM/None, and RTCM/NMEA. Each option lists the input format first, followed by the output format.

To select I/O format:

1. Highlight the I/O field and press **ENTER**.
2. Use the **▲** and **▼** keys to toggle through and select the desired setting, and press **ENTER**.

The GRMN/GRMN setting is a proprietary format that lets you exchange information such as waypoints, routes and track logs between two GARMIN GPS devices or a PC. During data transfer, the number of packets being exchanged will be displayed on screen.

To select a transfer option:

1. Highlight the 'HOST' field and press **ENTER**.
2. Use **▲** and **▼** to select a setting and press **ENTER**.

To disable all interfacing capabilities, select the None/None setting. If you want to output NMEA data to compatible external devices without any differential input capability, select the None/NMEA setting. Once a NMEA output setting has been selected (with or without RTCM input), the NMEA field will become highlighted. NMEA formats 0180, 0182 or 0183 (1.5 or 2.0) are available.

To select a NMEA format:

1. Press **ENTER** to begin a NMEA selection.
2. Use **▲** and **▼** to select a format, and press **ENTER**.



A field for additional information will be displayed when required for the selected interface option. Above, the None/NMEA option will allow input of NMEA versions and a baud rate.

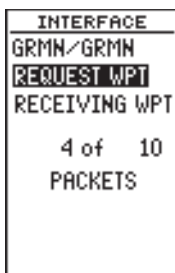

Choose a 'HOST' field based upon the type of information transfer you want to occur between the two interfacing devices.

DGPS Interface

INTERFACE	
RTCM/NONE	
1200	baud
BEACON RECUR	
FREQ	304.0KHz
RATE	100bps
DIST	--.m
SNR	--dB
Tuning	

The selectable baud rate is available for all RTCM interface options.

INTERFACE	
RTCM/NMEA	
NMEA	0183 2.0
4800	baud
BEACON RECUR	
FREQ	304.0KHz
RATE	100bps
DIST	--.m
SNR	--dB
Tuning	

Once a RTCM option is selected, you must manually tune the beacon receiver from the frequency field.

DGPS Interface

The last two format settings allow the differential-ready GPS 125 Sounder to accept RTCM DGPS corrections in RTCM 104 version 2.0 format. Using DGPS corrections will improve receiver accuracy to 5-10 meters, regardless of errors induced by the government's Selective Availability (SA) program. The RTCM/NONE format will allow connection to any manually tuned beacon receiver by using the proper output interface. The baud rate is selectable from the GPS 125 Sounder.

The RTCM/NMEA selection controls the GARMIN GBR-21 differential beacon receiver. Once a RTCM setting has been selected, the GPS 125 Sounder will either automatically try to tune the last frequency and bit rate you selected or will switch to the default frequency of 304.0 kHz with a bit rate of 100 bps if no previous beacon has been tuned. You may also enter your own frequency and bit rate if desired.

To enter a DGPS beacon frequency:

1. Highlight the 'FREQ' field and press **ENTER**.
2. Enter the desired frequency and press **ENTER**.
3. Highlight the 'RATE' field and press **ENTER**.
4. Use **▲** and **▼** to select the desired transmit rate.
5. Press the **ENTER** key to confirm your entry.

When the GPS 125 Sounder is receiving DGPS corrections from the GBR-21, the 'BEACON RECUR' section of the I/O setup page will display the beacon frequency and signal strength, as well as the distance from the transmitter to the beacon receiver. At the bottom of the beacon receiver field, a status message will keep you informed of DGPS activity:

- A 'Tuning' message will be displayed while a beacon signal is being tuned.
- Once the beacon signal has been tuned, a 'Receiving' message will be displayed.
- If a beacon signal is tuned and no corrections are being received, a 'No Data' message will be displayed.
- If a beacon signal cannot be tuned, a 'No Status' message will be displayed.

DGPS Interface & System Setup

The GPS 125 Sounder will also display one of three alert messages concerning DGPS operation through the message page:

No DGPS Position— not enough data is available to compute a DGPS position.

No RTCM Input— the beacon receiver is not properly connected or the baud rates do not match.

RTCM Input Failed— DGPS data was being received but has been lost.

System Setup

The first setup page is the system setup page, which is used to select the operating mode, time offset and screen preferences. The GPS 125 Sounder has four operating modes:

- **'Normal' Mode** is the mode used for actual navigation. Satellite data is acquired and used in figuring and displaying your position and movement.
- **'Simulator' Mode** allows you to operate the unit without acquiring satellites, and is ideal for practicing or entering waypoints and routes while at home.
- **'GPS Only' Mode** does not display any information on the Sounder Page. This is useful when using the unit for land navigation while enroute to the water.
- **'Sounder Only' Mode** will not display GPS information (such as position, speed, heading, and map functions).

To select an operating mode:

1. Highlight the 'MODE' field and press **ENTER**.
2. Use the arrow keypad to select a mode and press **ENTER**.



Alert messages will signal any problems with DGPS operation.



The GPS 125 Sounders four operating modes are accessed through the system setup submenu.

Setting Time, Screen Contrast, & Tone

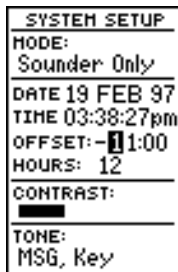

To display the correct local time, you must enter the appropriate offset from the chart at the end of Appendix C.

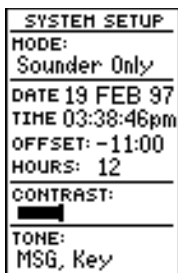

Screen contrast may be adjusted with the contrast bar.

Date and Time Setup

The date and time field is located directly below the mode field. Because the time shown is UTC time, you will need to enter a time offset to display the correct local time for your area. To determine the time offset for your area, note your position and refer to the chart in Appendix C.

To enter the time offset:

1. Highlight the 'OFFSET' field and press the **ENTER** key.
2. Enter the time offset and press **ENTER**. Remember to select a positive or negative indicator for your offset.

Time Format

The time display shown on the system setup and Position Pages may be set to display the time in a 12 or 24-hour format.

To select the time format:

1. Highlight the 'HOURS' field and press the **ENTER** key.
2. Select 12-or 24-hour display, and press **ENTER** to confirm.

Screen Contrast

The GPS 125 Sounder has adjustable screen contrast that is controlled by using an on-screen bar scale.

To set the screen contrast:

1. Move the field highlight to the 'CONTRAST' field and press the **ENTER** key.
2. Use the **◀** and **▶** keys to adjust the bar scale for the desired contrast and press the **ENTER** key.

Tone Setting

You may choose from three settings for audible tone: messages only, messages and keystrokes, or no tone at all.

To specify a tone setting:

1. Highlight the 'TONE' field and press the **ENTER** key.
2. Use the **▲** and **▼** keys to select the desired tone and press **ENTER**.

Navigation Setup

Navigation Setup

The navigation setup page is used to select units of measurement for position format, map datum, CDI scale, and distance, speed, and heading information.

Position Formats

The default position setting for the GPS 125 Sounder is latitude and longitude in degrees and minutes (hddd°mm.mmm'). You may also select degrees, minutes and seconds (hddd°mm'ss.s"); degrees only (hddd.dddd°); UTM/UPS coordinates; or British, German, Irish, Maidenhead, Swedish, Swiss, or Taiwan grid formats.

To select a position format:

1. Highlight the 'POSITION FRMT' field and press **ENTER**.
2. Use the **▲** and **▼** keys to select the desired setting. Confirm the setting by pressing **ENTER**.

Map Datums

The map datum field is located just below the position format field, and comes with a WGS 84 default setting. Although 104 total map datums are available for use (see the map datum listing in Appendix D), you should only change the datum if you are using maps or charts that specify a different datum than WGS 84.

To select a map datum:

1. Highlight the 'MAP DATUM' field and press **ENTER**.
2. Use the **▲** and **▼** keys to toggle through and select the desired setting. Confirm the setting by pressing **ENTER**.

CDI Scale Settings

The course deviation indicator (CDI) scale definition field lets you select the +/- range of the CDI bar scale. Three scales are available: +/- 0.25, 1.25 and 5.0 miles or kilometers, with 0.25 being the default setting.

To enter a CDI scale setting:

1. Highlight the 'CDI SCALE' field and press **ENTER**.
2. Use **▲** and **▼** to select the desired setting and press **ENTER**.

NAV SETUP
POSITION FRMT: hddd°mm.mmm'
MAP DATUM: WGS 84
CDI: ±0.25
UNITS: Nautical
SPEED FILTER: Auto
HEADING: Auto Mag E004

The position format may be set to display your choice of many formats. Note: degree and minutes is the default setting.

NAV SETUP
POSITION FRMT: hddd°mm.mmm'
MAP DATUM: WGS 84
CDI: ±0.25
UNITS: Nautical
SPEED FILTER: Auto
HEADING: Auto Mag E004

Adjusting the CDI Scale will determine the value used in the Highway Page and for the range rings on the Map Page (if displayed).

Navigation & Speed Filter

NAV SETUP
POSITION FRMT: hddd°mm.mmm'
HAF DATUM: WGS 84
CDI: ±0.25
UNITS: Nautical
SPEED FILTER: Auto
HEADING: Auto Mag E004

Choose a navigation unit you are familiar with or that may be appropriate to the situation in which the GPS 125 Sounder is used.

NAV SETUP
POSITION FRMT: hddd°mm.mmm'
HAF DATUM: WGS 84
CDI: ±0.25
UNITS: Nautical
SPEED FILTER: On 012 SEC
HEADING: Auto Mag E004

The number entered represents a window of time the GPS 125 Sounder considers in adjusting to changes in speed and track. For example, if 12 seconds is entered, the speed displayed will constantly represent the speed averaged over the last 12 seconds.

Units of Measure

The GPS 125 Sounder lets you select nautical (default), statute, or metric units of measure for all speed and distance fields.

To change the unit of measure:

1. Highlight the 'UNITS' field and press the **ENTER** key.
2. Use **▲** and **▼** to select the desired unit of measure.
3. Press the **ENTER** key to confirm the selection.

Speed Filter

NAV SETUP
POSITION FRMT: hddd°mm.mmm'
HAF DATUM: WGS 84
CDI: ±0.25
UNITS: Nautical
SPEED FILTER: Auto
HEADING: Auto Mag E004

The speed filter allows you to determine how the GPS 125 Sounder responds to changes in track or ground speed. Three settings are available: Auto, On, or Off. The 'Auto' setting is the default and will monitor the changes in your current track and speed and adjust the receiver's response time automatically. The 'On' setting allows you to manually enter a response time up to 300 seconds. Selecting a higher setting may be desirable in slow-speed applications with frequent changes in track.

To enter a value for the speed filter:

1. Highlight the 'SPEED FILTER' field and press **ENTER**.
2. Select the 'ON' option and press **ENTER**.
3. Highlight the "speed value" field and press **ENTER**.
4. Select the desired number of seconds and press **ENTER**.

Magnetic Heading & Map Setup

Magnetic Heading Reference

The GPS 125 Sounder's heading information can be displayed referencing magnetic north (auto or user-defined), true north, or calculated grid headings. The default setting is automatic magnetic north, which is suitable for most applications.

NAU SETUP	
POSITION FRMT:	hddd°mm. mmm'
MAP DATUM:	WGS 84
CDI:	±0.25
UNITS:	Nautical
SPEED FILTER:	On 2 SEC
HEADING:	True

To select a heading reference:

1. Highlight the 'HEADING' field and press **ENTER**.
2. Select the desired heading preference.
3. Press the **ENTER** key to confirm the selection.

To enter a user-defined magnetic heading:

1. Select the 'USER MAG' option and press **ENTER**.
2. Use the **▲** and **▼** keys to enter the degrees and direction of magnetic variation.
3. Press the **ENTER** key to confirm the magnetic variation value.

Map Setup and Orientation

The map setup page lets you select map orientation and specify what items are displayed. The map may be oriented to north up, the direction of current travel (track up) or the direction of an active route leg (desired track up). The default setting is track up.

To change the map orientation:

1. Highlight the 'ORIENTATION' field and press **ENTER**.
2. Use the **▲** and **▼** keys to toggle through and select the desired setting, and press **ENTER**.

NAU SETUP	
POSITION FRMT:	hddd°mm. mmm'
MAP DATUM:	WGS 84
CDI:	±0.25
UNITS:	Nautical
SPEED FILTER:	On 2 SEC
HEADING:	User Mag:E000

To enter a user-defined magnetic variation, select the 'User Mag' option and enter the desired direction and value.

MAP SETUP	
ORIENTATION:	North Up
PLOTTED ITEMS	
RINGS:	No
ROUTE:	Yes
NEAREST:	Yes
NAMES:	Yes
TRACK LOG:	250

The 'North Up' orientation causes the top-center of the Map Page to represent 000°, the right-center to be 090°, the bottom-center 180°, and the left-center to be 270°.

Map Setup

MAP SETUP	
ORIENTATION:	Track Up
PLOTTED ITEMS	
RINGS:	No
ROUTE:	Yes
NEAREST:	Yes
NAMES:	Yes
TRACK LOG:	250

On-screen range rings will appear on the map when the 'RINGS' option is set to the 'Yes' position.

MAP SETUP	
ORIENTATION:	North Up
PLOTTED ITEMS	
RINGS:	No
ROUTE:	Yes
NEAREST:	Yes
NAMES:	Yes
TRACK LOG:	50

A higher track log value will make a more detailed track log but will take up more memory.

Selecting Displayed Items on the Map Page

The rest of the map setup page lets you specify what items are displayed or plotted on the Map Page. The first four plot items may be turned on or off by selecting 'Yes' or 'No' in the appropriate field:

- The 'RINGS' selection will display the three present position range rings on the map.
- The 'ROUTE' selection will plot the straight leg lines between waypoints of an active route and display all route waypoint names.
- The 'NEAREST' selection will show the nine nearest waypoints to your present position (not the target crosshair on the map).
- The 'NAMES' selection will display the waypoint name for the nine nearest waypoints.

To turn a plotted item on or off:

1. Highlight the confirmation (Yes or No) field for the plotted item and press **ENTER**. Make your desired selection and press **ENTER**.

Track Log Display

The track log option sets the number of points the unit will attempt to display on the Map Page. The default setting of 250 points provides good resolution with minimal screen clutter. The maximum setting is 768 points. Once you've reached the maximum number of track points, the older points will be lost as new points are added. Adjusting the track points displayed will not affect whether or not the receiver records a track log or the ability to create a TracBack route.

To enter a log setting:

1. Highlight to the 'TRACK LOG' field and press **ENTER**.
2. Enter a value in the 3-digit field and press **ENTER**. If you do not want to display a track, enter '000'.

Alarms Setup

MENU
NEAREST WPTS
WAYPOINT LIST
WAYPOINT
ROUTES
DIST AND SUN
TRACK LOG
INTERFACE
SYSTEM SETUP
NAV SETUP
MAP SETUP
ALARMS SETUP
SOUNDER SETUP

The GPS 125 Sounder's alarms setup page is used to set the three available alarms: the anchor drag alarm, arrival alarm, and CDI alarm.

The anchor drag alarm will sound if your boat has moved outside a range measured from a central point (your position). The arrival alarm sounds when you are approaching a waypoint and have reached the user-defined distance. The CDI alarm will alert you when your track varies from the shortest distance to a waypoint by the defined range.

To set the alarms:

1. Highlight 'ALARMS SETUP' and press **ENTER**.
2. Select the desired alarm distance field and press **ENTER**.
3. Enter the distance for the alarm and press **ENTER**.
4. If you would like to change the 'On/Off' setting, press the **ENTER** key and use the **▲** or **▼** keys to turn the alarm on or off.
5. Enter a setting and and press **ENTER**.



When setting the anchor drag alarm, remember that Selective Availability can degrade your GPS position as much as 100 meters and may cause false anchor drag alerts.

REFERENCE

Alarms Setup

ALARMS SETUP	
Anchor Drag:	0.05% On
Arrival:	0.4% Off
CDI Alarm:	0.1% Off

The arrival alarm will sound at the determined distance from the destination waypoint.

ALARMS SETUP	
Anchor Drag:	0.05% On
Arrival:	0.4% Off
CDI Alarm:	0.1% Off

Use the anchor drag alarm as an indicator of movement due to possible anchor slippage.

Sounder Setup



Adjust the sensitivity range between 0 and 100. The default setting is 50.

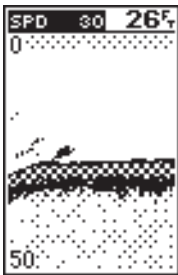

The chart speed may be adjusted between 10 (slowest) and 100. The default is 50.

Sounder Setup

The sounder setup page lets you customize the sounder to your needs and activate certain alarms. Access the Sounder Setup from the Menu Page.

MENU
NEAREST HPTS
WAYPOINT LIST
WAYPOINT
ROUTES
DIST AND SUN
TRACK LOG
INTERFACE
SYSTEM SETUP
NAV SETUP
MAP SETUP
ALARMS SETUP
SOUNDER SETUP



SOUNDER SETUP
SENSITIVITY? 50
CHART SPD? 100
WHITELINE? 5
RNG MODE AUTO
FISH ID OFF
NOISE REJ AUTO
UNITS FEET
KEEL +0.0
ALARMS
SHAL OFF 20.0
DEEP OFF 100.0
FISH OFF ALL

Sensitivity

The sensitivity setting determines how sensitive the sounder is to sonar echoes. High sensitivity may show clutter which can conceal fish, while low sensitivity may not show all fish. Note: A setting of 50% will give you the best results for most fishing situations.

To adjust sensitivity:

1. Highlight 'SENSITIVITY?' and press **ENTER**. The Sounder Page will appear with 'SENS' and a value displayed in the upper left corner of the page.
2. Press the arrow keypad up or down until the desired sensitivity level is shown and press **ENTER**.

Chart Speed

The chart speed field allows you to select the speed at which the sonar display scrolls across the screen.

To adjust chart speed:

1. Highlight 'CHART SPD?' and press **ENTER**. The Sounder Page will appear with 'SPD' and a value displayed in the upper left corner of the page.
2. Press the arrow keypad up or down until the desired chart speed is shown and press **ENTER**.

Whiteline & Fish ID

Whiteline

You may select how the area of strongest sonar return is shown through the whiteline setting. A high setting will cause a thick whiteline while low settings show a thin whiteline.

To adjust the whiteline:

1. Highlight 'WHITELINE?' and press **ENTER**. The Sounder Page will appear with 'WTLN' and a value displayed in the upper-left corner of the page.
2. Press the arrow keypad up or down until the desired whiteline level is shown and press **ENTER**.

Range Mode

You may select the range mode from this menu.

To select the auto or manual range mode:

1. Highlight the 'RNG MODE' field and press **ENTER**. The Manual/Auto field will be highlighted.
2. Press the arrow keypad up or down until the desired range mode is shown and press **ENTER**.

Fish ID

The Fish ID setting determines how the GPS 125 Sounder identifies and labels sonar targets on the screen. Three settings are available:

- OFF - is the default setting and shows all sonar target information in its unprocessed form.
- ON - shows small, medium, and large fish icons, along with each target's depth. Other echo information (thermoclines, thin stumps, etc.) is shown as a dotted pattern.
- FISH - shows fish icons and depth and does not show other echo information.

To select Fish ID:

1. Highlight the 'FISH ID' field and press **ENTER**. 'ON/OFF' will be highlighted.
2. Select the desired setting and press **ENTER**.



The whiteline may be adjusted from 0 (off) to 100. The default setting is 5.

SOUNDER SETUP	
SENSITIVITY?	50
CHART SPD?	100
WHITELINE?	5
RNG MODE	AUTO
FISH ID	OFF
NOISE REJ	AUTO
UNITS	FEET
KEEL	+0.0
ALARMS	
SHAL OFF	20.0
DEEP OFF	100.0
FISH OFF	ALL

The 'OFF' setting is the Fish ID default and will show sonar targets as arches.

Noise Rejection & Depth Units

SOUNDER SETUP	
SENSITIVITY?	50
CHART SPD?	100
WHITELINE?	5
RNG MODE	AUTO
FISH ID	OFF
NOISE REJ	AUTO
UNITS	FEET
KEEL	+0.0
ALARMS	
SHAL OFF	20.0
DEEP OFF	100.0
FISH OFF	ALL

Use the noise rejection feature to minimize interference from nearby electronics.

SOUNDER SETUP	
SENSITIVITY?	50
CHART SPD?	100
WHITELINE?	5
RNG MODE	AUTO
FISH ID	OFF
NOISE REJ	AUTO
UNITS	METERS
KEEL	+0.0
ALARMS	
SHAL OFF	6.1
DEEP OFF	30.5
FISH OFF	ALL

Choose a desired unit of measurement from feet, meters, or fathoms.

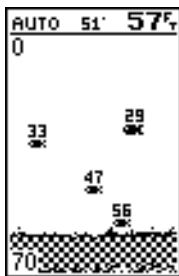

ID Setting - FISH

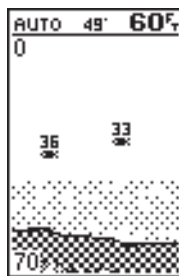

ID Setting - ON

The above examples illustrate the difference between having Fish ID set to “FISH” versus “ON”. The most information is available with the “ON” setting.

Noise Rejection

The noise rejection setting determines how much the unit screens out electronic interference from nearby equipment. The “Auto” setting is the default and will turn noise rejection on and off as needed.

To set noise rejection:

1. Highlight the ‘NOISE REJ’ field and press **ENTER**. The AUTO/ON/OFF field will be highlighted.
2. Press the arrow keypad up or down until the desired mode is shown and press **ENTER**.

Depth Units

The depth units field allows you to determine whether sounder depth is displayed in feet, meters, or fathoms.

To set the depth units:

1. Highlight ‘UNITS’ and press **ENTER**. The ‘FEET/METERS/FATHOM’ field will be highlighted.
2. Press the arrow keypad up or down until the desired depth unit is shown and press **ENTER**.

Keel Offset & Sounder Alarms

Keel Offset

This setting allows you to set the point from which the GPS 125 Sounder will measure depth. This makes it possible to measure depth from the bottom of the keel instead of from the transducer's location. A positive number will measure depth from a deeper point while a negative number reflects a shallower point.

To set keel offset:

1. Highlight the 'KEEL' field and press **ENTER**. The value field will be highlighted.
2. Select plus (+) or minus (-) and press **ENTER**. The highlight will move to the value field.
3. Enter the desired offset value using the arrow keypad and press **ENTER**.

Sounder Alarms

This field allows you to set shallow and deep depth alarms and an alarm for specific-sized fish/targets. Three options are available:

- Shallow water - Has an on/off setting and a depth value field
- Deep water - Has an on/off setting and a depth value field
- Fish - Has an on/off setting and a medium/large/all size field

To set a sounder alarm:

1. Highlight the desired alarm and press **ENTER**. The on/off setting will be highlighted.
2. Use the arrow keypad to select 'ON' or 'OFF' and press **ENTER**. The highlight will move to the value field.
3. Enter the desired value using the arrow keypad and press **ENTER**.

SOUNDER SETUP	
SENSITIVITY?	50
CHART SPD?	100
WHITELINE?	5
RNG MODE	AUTO
FISH ID	FISH
NOISE REJ	AUTO
UNITS FEET	
KEEL	+00.0
ALARMS	
SHAL OFF	20.0
DEEP OFF	100.0
FISH OFF	ALL

Use the keel offset to customize the point used to measure depth.

SOUNDER SETUP	
SENSITIVITY?	50
CHART SPD?	100
WHITELINE?	5
RNG MODE	AUTO
FISH ID	OFF
NOISE REJ	AUTO
UNITS FEET	
KEEL	+0.0
ALARMS	
SHAL	ON 20.0
DEEP OFF	100.0
FISH OFF	ALL

The alarms can be set to activate at a specified shallow and deep water depth and when any sonar targets appear.

Nav Simulator

Navigation Simulator

The GPS 125 Sounder's simulator mode lets you practice all aspects of operation without actually tracking satellites. You can also plan and practice trips, enter new waypoints and routes, and save them for use during normal operation. The simulator is activated from the system setup page, with speed and heading controlled from the Position, Compass, or Highway Pages.



To activate the simulator:

1. Highlight 'SYSTEM SETUP' and press **ENTER**.
2. Highlight the 'MODE' field and press **ENTER**.
3. Use **▲** or **▼** to select the simulator mode.
4. Press the **ENTER** key to confirm.
5. Press **ENTER** to return to the Menu Page.

Once the simulator mode has been activated, use the Position, Compass, or Highway Page to set your speed, track and simulated depth.

00 345 N 015 03	
TRACK	SPEED
000°	00.0%
TRIP	ALT
0.0%	1081%
POSITION	
N 37°39.950'	
W 045°59.030'	
03:53:39pm	
DPT	48%

To enter track, speed, position, and depth:

1. Highlight the 'TRACK' field and press the **ENTER** key.
2. Enter a track and press **ENTER**.
3. Highlight the 'SPEED' field and press **ENTER**.
4. Enter a speed and press **ENTER**.
5. Highlight the 'POS' field and press **ENTER**.
6. Enter a position and press the **ENTER** key.
7. Highlight the 'DPT' field and press **ENTER**.
8. Enter a depth and press the **ENTER** key.



The GPS 125 Sounder does not track satellites or receive sonar signals in simulator mode. Although you can create and save waypoints and routes while using the simulator mode, never attempt to use the simulator mode for actual navigation or fishing/depth sounding.

Installation

Installation

The GPS 125 Sounder must be properly installed according to the following instructions to get the best possible performance.

To begin installation, you'll need to select a suitable mounting position for the antenna, unit and transducer (see right). Once you've identified the best mounting location, install the antenna, transducer, and cable first, and then the unit and wiring harness.

Choosing an Antenna Location

The antenna should be mounted in a location that has a clear, unobstructed view of the sky in all directions to ensure the best reception in all conditions. Avoid mounting the antenna where it will be shaded by the boat's superstructure, a radome antenna, or mast. Most marine VHF and Ioran antennas will not seriously degrade the GPS antenna's reception. Never paint the antenna or clean it with harsh solvents.

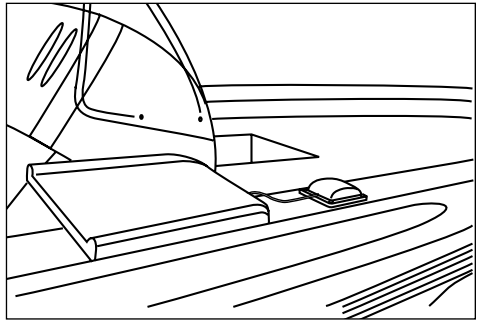
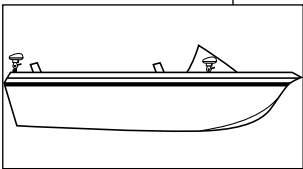
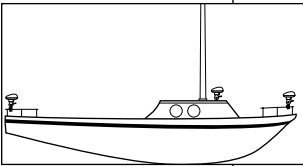

Typical Bass Boat Installation

Installation

Two types of antenna assemblies are used with the GPS 125 Sounder:

- White, GA28 Marine Antenna with 30 ft. cable and BNC connector
- Black, GA26 Low-Profile Antenna with 8 ft. cable, BNC connector, flange, and Velcro™ mounting hardware.

Mounting the White, GA28 Antenna**To install the GA28 antenna:**

1. Attach a 1" X 14 mount (not included) to the desired antenna location using the appropriate fasteners.
2. Screw the antenna directly onto the 1" X 14 mount.
3. Route the cable to the location of the GPS 125 Sounder, using the appropriate tie-wraps, escutcheon plates, and sealant to secure the cable along the route and through any bulkhead or deck.
4. Once the GPS 125 Sounder unit has been installed, connect the cable to the antenna connector on the back of the unit. Turn the antenna connector 1/4 turn clockwise to lock the cable into place.

**Transducer Installation:**

For instructions on transducer installation, see the booklet included with your transducer.

Mounting the GPS 125 Sounder

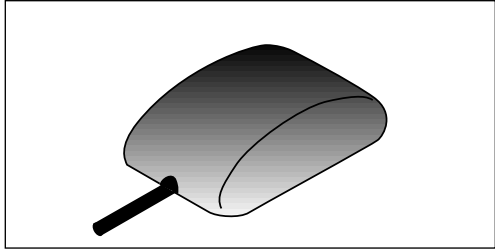

Two types of mounting options are included with the GA26:

- Flange Mount Bracket
- Dual-Lock Velcro Strips

The flange mount bracket is useful for permanent antenna mounting on a flat surface.

The dual-lock Velcro should be considered permanent even though it does not require drilling. The adhesive used to attach the Velcro to the antenna and the mounting surface is very strong. Removing an item attached with dual-lock Velcro could result in damage to the antenna or to the mounting surface.

To flange mount the GA26 antenna:

1. Attach the flange mount bracket to the GA26 using the two M3 screws included with the antenna.

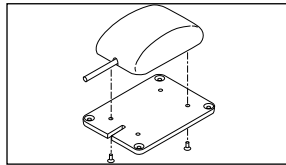

Mounting the GA 26 Antenna (cont.)

- Using the mounting bracket as a template, mark and then drill four 0.115-.125" holes.
- If necessary, apply silicone sealant between the mounting surface and flange mount and then attach the antenna to the mounting surface with appropriate screw (not included).

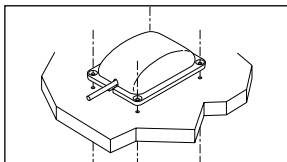

- Note: If installation requires that the antenna cable be routed through the mounting surface, you will need to make a 0.700" cable hole in the mounting surface.

To Velcro mount the GA26 antenna:

- Ensure the mounting surface and the back of the GA26 antenna are both clean.
- Remove the backing from each of the Velcro strips, attach them to the desired locations, and press the antenna onto the mounting surface.

Mounting the GPS 125 Sounder

The GARMIN GPS 125 Sounder's compact case is suitable for mounting in exposed locations or at the nav station. The unit comes with a gimbal bracket that can be used for surface, overhead, or flush mounting. When choosing a location for the display unit, make sure you consider the following conditions:

Installation

WARNING
 Power source
 is greater than
 18 volts.
 Please Check
 your power
 connection to
 avoid damage
 to the unit.
 PRESS ENTER

WARNING

If your power source ever exceeds 18 volts, the above warning page will appear. The GPS 125 Sounder will automatically discontinue standard operation to avoid system overload and will allow only screen backlighting operation.

Should this warning appear, you should check your power source and reduce voltage to the unit to between 12 and 18 volts.

Mounting the GPS 125 Sounder (cont.)

- There should be at least 2.00" (5.0 cm) clearance behind the case to allow connection of the antenna, power/data cable, and transducer cable.
- The mounting surface should be rigid enough to support the unit and protect it from excessive vibration and shock.
- The GPS 125 Sounder screen has crisp contrast in most lighting conditions, even full sunlight.

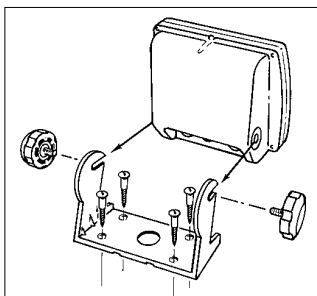
To surface mount the GPS 125 Sounder:

1. Place the mounting bracket in the desired location.
2. Mark and drill the four mounting holes for the fasteners you are using.
3. Fasten the bracket to the surface using the appropriate fasteners.
4. Insert the GPS 125 Sounder into the mounting bracket.
5. Screw the two mounting knobs through the bracket and into the GPS 125 Sounder.
6. Connect the power/data, antenna, and transducer cables to the back of the unit, making sure the locking rings are fully tightened on both connectors.

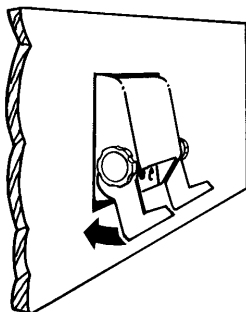
To flush mount the GPS 125 Sounder:

The GPS 125 Sounder can be mounted flush with a flat panel of .08-.52" thickness using the cam lobe feature on its mounting bracket.

1. Cut a 4.15" W x 4.67" H hole in panel.
2. Place GPS 125 Sounder into hole from the front until its flange rests against the mounting surface.
3. From the back side of the panel, loosely attach the bracket such that the slot in the ratchet area points away from the mounting panel.
4. Rotate the bracket downward until the panel is pinched tightly between the units flange and bracket lobe.
5. Tighten knobs and connect the power/data, antenna, and transducer cables.

Wiring & Specifications

Connecting the power/data cable

The power/data cable connects the GPS 125 Sounder system to a 12-18 volt DC power source and provides interface capabilities for connecting NMEA devices and an external alarm (see below for interface operation details). The diagram below indicates the appropriate harness connections.

To connect the GPS 125 Sounder to a power source:

1. Connect the RED harness lead to the positive side of a 12-18 volt DC power source. Make sure the power lead has an in-line 1-amp fuse installed.
2. Connect the BLACK harness lead to a ground strip or the negative side of a 12-18 volt DC power source.

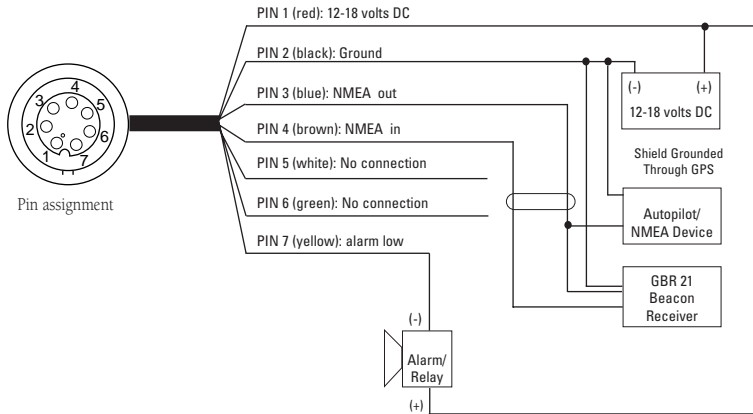

To connect an external alarm, connect the ground side of the alarm device to the YELLOW harness lead. (100 mA DC load max.) The following interface formats are supported by the GPS 125 Sounder for driving three NMEA devices:

NMEA 0180, NMEA 0182,

NMEA 0183 version 1.5:

Approved sentences:

GPBWC, GPGLL, GPRMB, GPRMC,
GPXTE, GPVTG, GPWPL

Proprietary sentences:

PGRMM (map datum), PGRMZ
(altitude), PSLIB (beacon rec. control)

NMEA 0183 version 2.0:

Approved sentences:

GPGGGA, GPGLL, GPGSA, GPGSV,
GPRMB, GPRMC, GPRTE, GPWPL

Proprietary sentences:

PGRME (estimated error), PGRMM
(map datum), PGRMZ (altitude), PSLIB
(beacon receiver control)

The GPS 125 Sounder is constructed of high-quality materials and should not require user maintenance. Should your unit ever need repair, please take it to an authorized GARMIN service center. The GPS 125 Sounder has no user-serviceable parts. Never attempt any repairs yourself.

To protect your GPS, never allow gasoline or other solvents to come in contact with the case or screen. Clean the case and screen with a soft cloth and a household window cleaner.

PHYSICAL

Case:	gasketed-construction
Size:	4.9"H x 5.3"W x 2.4"D (15.6 x 5.1 x 1.23 cm)
Weight:	Less than 1 lb. (454g)
Temperature Range:	5° to 158°F (-15° to 70°C)

PERFORMANCE

Receiver:	Differential-ready MultiTrac8™
Acquisition Time:	Approx. 20 seconds (warm) Approx. 2 minutes (cold) Approx. 7.5 minutes (AutoLocate™)
Update Rate:	1/second, continuous
Position Accuracy:	5-10 meters (16-33 ft.) with DGPS corrections* 15 meters (49 ft.) RMS**
Velocity Accuracy:	0.1 knot RMS steady state, 99 knots max.
Dynamics:	Performs specification to 3g's

POWER

Input:	12-18v DC
Usage:	5 watts

Specifications subject to change without notice

* With optional GARMIN GBR 21 Beacon Receiver Input.

** Subject to accuracy degradation to 100m 2DRMS under the US DOD-imposed elective Availability Program.

Messages & Time Offsets

The GPS 125 Sounder uses a flashing on-screen message to alert you to important information. Whenever the message indicator appears, press the PAGE key to view the message page. There are two types of messages: temporary alerts and condition alerts. Temporary alerts are cleared from the message page after viewing, while condition alerts remain on the message page until the condition has been resolved. Pay careful attention to all messages for your own safety.

Active WPT Can't be Deleted—You have attempted to change the “active to” or “active from” waypoint. Clear the active route or GOTO before making your changes.

Accuracy has been Degraded—The accuracy of the GPS 125 Sounder has been degraded beyond 500 meters due to poor satellite geometry or data quality. You should check other navigational sources to verify the position indicated.

Already Exists—The name you are entering already exists in the GPS 125 Sounder's memory.

Approaching—You are one minute away from reaching a destination waypoint.

Deep Water Alarm—The current depth is equal to or more than the set alarm depth.

No DGPS Position—Not enough data is available to compute a DGPS position.

No RTCM Input—Beacon receiver is improperly connected or baud rates do not match.

Poor GPS Coverage—The GPS 125 Sounder cannot acquire the necessary number of satellites to compute a position. Try another location with a clearer view of the sky.

Power Down and Re-init—The GPS 125 Sounder is not able to calculate a position due to abnormal satellite conditions. Turn the unit off and verify the last position shown by other means. Try the unit again later, possibly in a different location.

Read Only Mem has Failed—The permanent memory has failed and the unit is not operable. Take your unit to an authorized GARMIN dealer for repairs.

Received an Invalid WPT—A waypoint was received during upload transfer that has an invalid identifier.

Receiver has Failed—A failure in receiver hardware has been detected. If this message persists, do not use the unit and take it to an authorized dealer for repair.

Route is Full—You have attempted to add more than 30 waypoints to a route.

Route is not Empty—You have attempted to copy into a route already in use.

Route Waypoint Can't be Deleted—The waypoint you are trying to delete is part of a route. Delete the waypoint from the route before removing it from memory.

Route Waypoint was Deleted—A route waypoint entered does not exist in the database and has been deleted from the route.

RTCM Input has Failed—DGPS data being received has been lost. You are no longer receiving the beacon signal.

Route Waypoint was Deleted—A route waypoint entered does not exist in the database and has been deleted from the route.

Messages & Time Offsets

RTCM Input has Failed—DGPS data being received has been lost. You are no longer receiving the beacon signal.

Searching the Sky—The GPS 125 Sounder is in searching the sky for almanac data or the unit is in AutoLocate™ mode.

Shallow Water Alarm—The depth is equal to or less than the set alarm depth

Sonar ASIC has Failed—The unit's internal monitoring system indicates a malfunction. Send in for service as soon as possible.

Stored Data was Lost—All waypoints, routes, time and almanac data has been lost due to battery failure or clearing the receiver's memory.

Transfer has been Completed—The receiver is finished uploading or downloading information to the connected device.

No Transducer-Sounder Off—The transducer signal is not reaching the unit because of a loose connector, bad wiring, or transducer malfunction.

WPT Memory is Full—You have used all 250 waypoints in the GPS 125 Sounder. Delete unwanted waypoints to make room for new entries.

The chart below gives the UTC time offset for the various longitudinal zones. If you are in daylight savings time, add one hour to the offset.

Longitudinal Zone	Offset	Longitudinal Zone	Offset
W180.0° to W172.5°	-12	E007.5° to E022.5°	1
W172.5° to W157.5°	-11	E022.5° to E037.5°	2
W157.5° to W142.5°	-10	E037.5° to E052.5°	3
W142.5° to W127.5°	-9	E052.5° to E067.5°	4
W127.5° to W112.5°	-8	E067.5° to E082.5°	5
W112.5° to W097.5°	-7	E082.5° to E097.5°	6
W097.5° to W082.5°	-6	E097.5° to E112.5°	7
W082.5° to W067.5°	-5	E112.5° to E127.5°	8
W067.5° to W052.5°	-4	E127.5° to E142.5°	9
W052.5° to W037.5°	-3	E142.5° to E157.5°	10
W037.5° to W022.5°	-2	E157.5° to E172.5°	11
W022.5° to W007.5°	-1	E172.5° to E180.0°	12
W007.5° to E007.5°	0		

Map Datums

The following list shows the 104 map datums available for the GPS 125 Sounder. Abbreviations are listed first, followed by the corresponding map datum name and area.

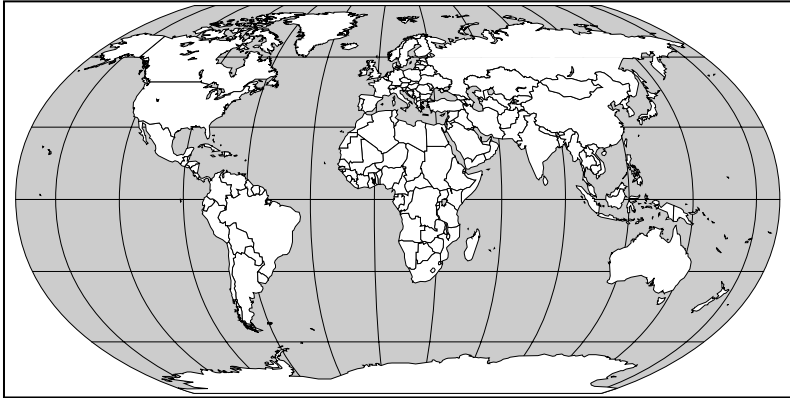

Adindan	Adindan- Ethiopia, Mali, Senegal, Sudan	Bogata Observ	Bogata Observatry- Colombia
Afgooye	Afgooye- Somalia	Campo Inchspe	Campo Inchauspe- Argentina
AIN EL ABD '70	AIN EL ANBD 1970- Bahrain Island, Saudi Arabia	Canton Ast '66	Canton Astro 1966- Phoenix Islands
Anna 1 Ast '65	Anna 1 Astro '65- Cocos Isl.	Cape	Cape- South Africa
ARC 1950	ARC 1950- Botswana, Lesotho, Malawi, Swaziland, Zaire, Zambia, Zimbabwe	Cape Canavrl	Cape Canaveral- Florida, Bahama Islands
ARC 1960	ARC 1960- Kenya, Tanzania	Carthage	Carthage- Tunisia
Ascnsn Isl'd '58	Ascension Island '58- Ascension Island	CH-1903	CH 1903- Switzerland
Astro B4 Sorol	Astro B4 Sorol Atoll- Tern Island	Chatham 1971	Chatham 1971- Chatham Island (New Zealand)
Astro Bcn "E"	Astro Beacon "E"- Iwo Jima	Chua Astro	Chua Astro- Paraguay
Astro Dos 71/4	Astro Dos 71/4- St. Helena	Corrego Alegr	Corrego Alegre- Brazil
Astr Stn '52	Astronomic Stn '52- Marcus Island	Djakarta	Djakarta (Batavia)- Sumatra Island (Indonesia)
Astrln Geod '66	Australian Geod '66- Australia, Tasmania Island	Dos 1968	Dos 1968- Gizo Island (New Georgia Islands)
Astrln Geod '84	Australian Geod '84- Australia, Tasmania Island	Easter Isl'd 67	Easter Island 1967
Bellevue (IGN)	Efate and Erromango Islands	European 1950	European 1950- Austria, Belgium, Denmark, Finland, France, Germany, Gibraltar, Greece, Italy, Luxembourg, Netherlands, Norway, Portugal, Spain, Sweden, Switzerland
Bermuda 1957	Bermuda 1957- Bermuda Islands		

Map Datums

European 1979	European 1979- Austria, Finland, Netherlands, Norway, Spain, Sweden, Switzerland	Massawa	Massawa- Eritrea (Ethiopia)
Finland Hayfrd	Finland Hayford- Finland	Merchich	Merchich- Morocco
Gandajika Base	Gandajika Base- Republic of Maldives	Midway Ast '61	Midway Astro '61- Midway
Geod Datm '49	Geodetic Datum '49- New Zealand	Minna	Minna- Nigeria
Guam 1963	Guam 1963- Guam Island	NAD27 Alaska	North American 1927- Alaska
Gux 1 Astro	Gux 1 Astro- Guadalcanal Island	NAD27 Bahamas	North American 1927- Bahamas (excluding San Salvador Island)
Hjorsey 1955	Hjorsey 1955- Iceland	NAD27 Canada	North American 1927- Canada and Newfoundland
Hong Kong '63	Hong Kong '63- Hong Kong	NAD27 Canal Zone	North Am. 1927- Canal Zone
Hu-Tzu-Shan	Hu-Tzu-Shan- Taiwan	NAD27 Caribbn	North American 1927- Caribbean (Barbados, Caicos Islands, Cuba, Dom. Rep., Grand Cayman, Jamaica, Leeward and Turks Islands)
Indian Bngldsh	Indian- Bangladesh, India, Nepal	NAD27 Central	North American 1927- Central America (Belize, Costa Rica, El Salvador, Guatemala, Honduras, Nicaragua)
Indian Thailand	Indian- Thailand, Vietnam	NAD27 CONUS	North Am. 1927- Mean Value (CONUS)
Indonesia '74	Indonesia 1974- Indonesia	NAD27 Cuba	North American 1927- Cuba
Ireland 1965	Ireland 1965- Ireland	NAD27 Grnland	North American 1927- Greenland (Hayes Peninsula)
ISTS 073 Astro	ISTS 073 ASTRO '69- Diego Garcia	NAD27 Mexico	N. American 1927- Mexico
Johnston Island	Johnston Island Kandawala Kandawala- Sri Lanka	NAD27 San Sal	North American 1927- San Salvador Island
Kerguelen Islnd	Kerguelen Island	NAD83	North American 1983- Alaska, Canada, Central America, CONUS, Mexico
Kertau 1948	Kertau 1948- West Malaysia, Singapore		
L. C. 5 Astro	Cayman Brac Island		
Liberia 1964	Liberia 1964- Liberia		
Luzon Mindanao	Luzon- Mindanao Island		
Luzon Philippine	Luzon- Philippines (excluding Mindanao Island)		
Mahe 1971	Mahe 1971- Mahe Island		
Marco Astro	Marco Astro- Salvage Island		

Map Datums

Nhrwn Masirah	Nahrwn- Masirah Island (Oman)	Sapper Hill '43	Sapper Hill 1943- East Falkland Island
Nhrwn Saudi A	Nahrwn- Saudi Arabia	Schwarzeck	Schwarzeck- Namibia
Nhrwn United A	Nahrwn- United Arab Emirates	Sth Amrcn '69	South American '69- Argentina, Bolivia, Brazil, Chile, Colombia, Ecuador, Guyana, Paraguay, Peru, Venezuela, Trinidad and Tobago
Naparima BWI	Naparima BWI- Trinidad and Tobago	South Asia	South Asia- Singapore
Obsrvtorio '66	Observatorio 1966- Corvo and Flores Islands (Azores)	SE Base	Southeast Base- Porto Santo and Madiera Islands
Old Egyptian	Old Egyptian- Egypt	SW Base	Southwest Base- Faial, Graciosa, Pico, Sao Jorge and Terceira Islands (Azores)
Old Hawaiian	Old Hawaiian- Mean Value	Timbalai 1948	Timbalai 1948- Brunei and E. Malaysia (Sarawak and Sabah)
Oman	Oman- Oman	Tokyo	Tokyo- Japan, Korea, Okinawa
Ord Srvy GB	Old Survey Grt Britn- England, Isle of Man, Scotland, Shetland Isl., Wales	Tristan Ast '68	Tristan Astro 1968- Tristan da Cunha
Pico De Las Nv	Canary Islands	Viti Levu 1916	Viti Levu 1916- Viti Levu/ Fiji Islands
Ptcairn Ast '67	Pitcairn Astro '67- Pitcairn Isl.	Wake-Eniwetok	Wake-Eniwetok- Marshall Isl.
Prov S Am '56	Prov So Amrcn '56- Bolivia, Chile, Colombia, Ecuador, Guyana, Peru, Venezuela	WGS 72	World Geodetic System 1972
Prov S Chln '63	Prov So Chilean '63- S. Chile	WGS 84	World Geodetic System 1984
Puerto Rico	Puerto Rico & Virgin Islands	Zanderij	Zanderij- Surinam
Qatar National	Qatar National- Qatar		
Qornoq	Qornoq- South Greenland		
Reunion	Reunion- Mascarene Island		
Rome 1940	Rome 1940- Sardinia Island		
RT 90	Sweden		
Santo (Dos)	Santo (Dos)- Espirito Santo Island		
Sao Braz	Sao Braz- Sao Miguel, Santa Maria Islands (Azores)		

A	
Almanac Data	.2
Alarms Setup	.57
B	
Backlighting	.9
Bearing (BRG)	.2
C	
Cancelling a GOTO	.14, 28
CDI Scale Settings	.53
Compass Page	.9
Connecting the Power/Data Cable	.70
Course Made Good (CMG)	.2
Crosstrack Error (XTE)	.2
D	
Date and Time Setup	.52
Desired Track (DTK)	.2
DGPS Interface	.50
Differential GPS (DGPS)	.2
Distance and Sun Calculation	.47
E	
Estimated Time Enroute (ETE)	.2
Estimated Time of Arrival (ETA)	.2
EZinit	.6
G	
Getting Started Tour	.7
Glossary	.2
Ground Speed (SOG)	.2
H	
Highway Page	.9
I	
Initialization Troubleshooting	.7
Initializing the Receiver	.5-6
Installation	.64
Interface Options	.49
Interface Setup	.49
Introduction	.iii
L	
Latitude	.3
Longitude	.3
M	
Magnetic Heading Reference	.54
Man Overboard Function	.28
Map Datums	.53, 74
Map Page	.9
Clearing a Cluttered Map Display	.17
Map Setup and Orientation	.55
Selecting Items on the Map Page	.56
Track Log Display	.56
Track Log Setup	.47
Using the Cursor on the Map	.43
Using the Position and Map Pages	.11
Zooming, Panning, and Pointing	.42
Zoom Scale	.42
Menu Page	.9
Messages	.72
Mounting the Antenna	.65
Mounting the GPS 125 Sounder	.67
N	
Navigation Basics	.4
Navigation Page	.9
Navigation Setup	.53
Navigation Simulator	.10, 62
O	
Operating Modes	.51
P	
Position	.3
Position Formats	.53
Position Page	.8
Power Input	.70
Power Overload Message	.68
Power Usage	.70
Primary Pages	.8

Index

- R**
- Receiver Status19
 - Routes31-36
 - Active From Waypoint31
 - Active Leg31
 - Active Route Page35
 - Active To Waypoint31
 - Activating and Inverting34
 - Copying33
 - Clearing33
 - Creating and Navigating31
 - Editing35
 - On-Route GOTOs36
 - Route Definition Page32
- S**
- Satellite Page8
 - Screen Contrast52
 - Selecting a GOTO Destination12
 - Sounder Page8
 - Auto Range Mode15
 - Chart Speed58
 - Depth Controlled Gain (DCG)37
 - Depth Units60
 - Fish Icon37
 - Fish ID59
 - Keel Offset61
 - Manual Range Mode15
 - Moving the Zoom Window16
 - Noise Rejection60
 - Range Modes15, 59
 - See-Thru Technology37
 - Sensitivity3, 58
 - Sounder Alarms61
 - Sounder Setup40, 58
 - Sounder Zoom15
 - Thermocline3, 14
 - Underwater Waypoint Feature15, 38
 - Using the Sounder Page14
 - Whiteline3, 59
 - Zoom Function39
- Specifications71
- Speed Filter54
 - Speed Over Water (SOW)3
 - Starting/Stopping a GOTO28
 - System Setup51
- T**
- Table of Contents1
 - Temperature Range71
 - Time Format52
 - Time Offsets73
 - Tips On Using the TracBack Feature30
 - Tone Setting52
 - TracBack Navigation29
 - Track (TRK)3
 - Track Criteria48
 - Transducer Installation65
 - Trip Odometer20
 - Turning the GPS 125 Sounder Off7
 - Turning the GPS 125 Sounder On6
- U**
- Units of Measure54
 - Universal Transverse Mercator (UTM)3
 - Using the Compass Page46
 - Using the Highway Page13, 45
- V**
- Velocity Made Good (VMG)3
- W**
- Waypoint3
 - Editing26
 - Going To a Waypoint12
 - Marking a Waypoint10, 21
 - Nearest Waypoints Page22
 - Reference Waypoints25
 - Deleting26
 - Renaming26
 - Scanning Waypoints27
 - Waypoint Comments26
 - Waypoint Definition Page24
 - Waypoint List Page23

LIMITED WARRANTY

GARMIN Corporation warrants this product to be free from defects in materials and workmanship for one year from the date of purchase. GARMIN will at its sole option, repair or replace any components which fail in normal use. Such repairs or replacement will be made at no charge to the customer for parts or labor. The customer is, however, responsible for any transportation costs. This warranty does not cover failures due to abuse, misuse, accident or unauthorized alteration or repairs. GARMIN assumes no responsibility for special, incidental, punitive or consequential damages, or loss of use.

The warranties and remedies contained herein are exclusive and in lieu of all other warranties expressed or implied, including any liability arising under warranty of merchantability or fitness for a particular purpose, statutory or otherwise. This warranty gives you specific legal rights, which may vary from state to state.

To obtain warranty service, call the GARMIN Customer Service department (913-397-8200) for a returned merchandise tracking number. The unit should be securely packaged with the tracking number clearly marked on the outside of the package, and sent freight prepaid and insured to a GARMIN warranty service station. A copy of the original sales receipt is required as the proof of purchase for warranty repairs. GARMIN retains the exclusive right to repair or replace the unit or software at its sole discretion.



© 1997 GARMIN Corporation

1200 E. 151st Street, Olathe, KS USA 66062

GARMIN (Europe) LTD - Unit 5, The Quadrangle,
Abbey Park Industrial Estate, Romsey, UK SO51 9AQ

Part Number 190-00111-00 Rev. B Printed in Taiwan